

fischer 

Catalogue Solar systems



**„Our innovative strength
and technological
know-how strengthen
our position on the
market.“**



Foreword

Dear partners,

For 75 years, we've been bringing greater efficiency and reliability to the construction industry through ground-breaking innovations and the best quality. As our valued customer, you have our support throughout every stage of your construction project. From planning and design to on-site support on the construction site until the project's successful completion, we are a strong partner at your side – in any part of the world.

Our wide range of plastic plugs, steel anchors, chemical fixing systems and screws also includes system solutions perfectly tailored to your applications. We're also driving digitalisation in the construction industry by providing you with project planning support through our engineering services, BIM solutions and many more digital services. But that's not all: Our BauBot construction robot enables autonomous drilling on the construction site, while our fischer Construction Monitoring sensor innovation provides an efficient IoT solution for monitoring prestressing forces in fixings.

With our products and services, you can also master any fastening situation while installing photovoltaic systems, from smaller installations around the home to large-scale industrial facilities. The extensive spectrum includes systems for various roof types and covers as well as different solar panel layouts and directions. Rails, roof hooks, clamps, double threaded screws and other accessories form the ideal system solution for installers and system providers of PV modules and systems.

Thanks to the high quality of the products, our fixing solutions guarantee lasting safety and functionality of the solar installation throughout its entire lifespan. Our systems furthermore guarantee that PV modules and solar thermal panels can be installed quickly and safely without requiring a large amount of specialist tools or major alterations to the roof. In short, our products and

services enable clients to drive the energy transition while ensuring sustainable building maintenance and reducing operating costs.

Returning to the subject of digitalisation: Our new SOLARPANEL-FIX software in our FiXperience suite makes planning and calculating installation systems for photovoltaics simple. By locating the construction site through geolocalisation, the tool calculates snow and wind loads, among other things. As a result, the software generates a full parts list for creating the PV substructure, assembly instructions as well as verification of the calculations.

This catalogue is designed to be a valuable companion in your daily work and to help you find the best solar fixings. We hope you enjoy reading this catalogue and using our products!



Andreas Voll

CEO of the fischer Group of Companies



„Whoever chooses fischer receives more than a range of safe products. The aim is to always develop the best solutions for our customers across the globe.“

Besides the innovative products, this predominantly concerns support that is focused on the customer, and services designed to improve customer benefit.

A brand and its promise to perform.

Continuous improvement

The fischer ProzessSystem (fPS) we ensure that we readapting and optimising our processes in line with customer requirements in a flexible manner and on a continuous basis.

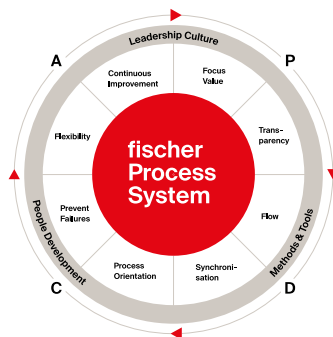

Safety that connects. Decisive quality

We don't make any compromises when it comes to the safety of our products. A whole host of our products are distinguished by comprehensive, up-to-date and international approvals. The fischer product range is well-positioned in all sectors of fixing technology – Steel, Nylon and Chemical fixings. In awardwinning quality which continues to impress both professional clients and private customers with equal measure.



See ICC-ES Evaluation Report at www.icc-es.org



International approvals characterise many of our products.

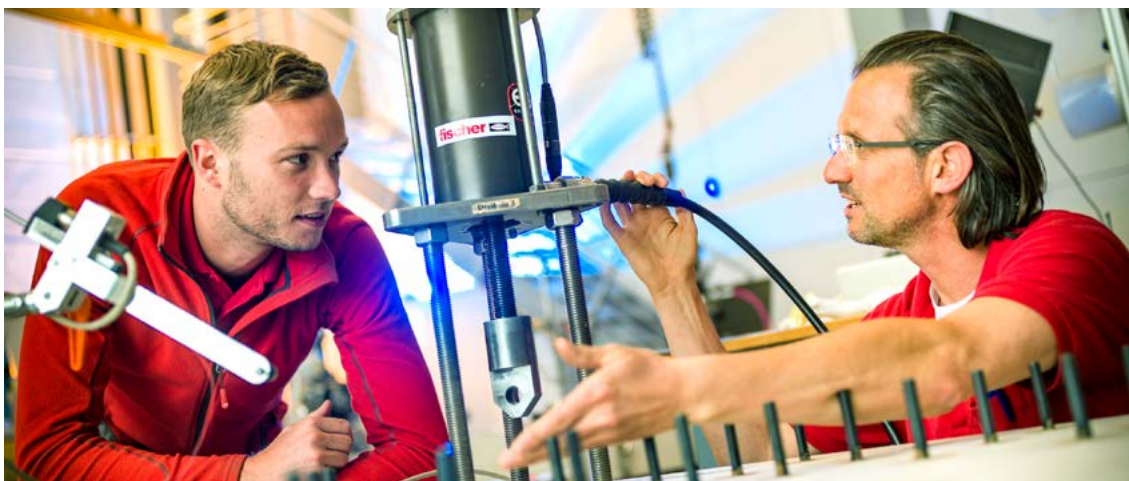



Always on the pulse of time

At fischer, innovation is more than just a sum of the patents. We are open to new things and are prepared for change – always with the aim of offering our customers the greatest possible benefits. Over the years, our own development and production sites have been developing numerous fixing solutions for the most wide-ranging applications. Be it new production procedures or materials, such as renewable raw materials: We are carrying out the research for your safety and will continue to do so in the future. This gives us such great flexibility that we can even develop tailor-made customer solutions. This power to innovate has seen fischer become market leader in anchor technology and the fixing industry.

Our service to you

We are a reliable partner, one that will stand at your side and address your individual requirements with advice and action:

- Our products range from chemical systems to steel anchors through to plastic anchors.
- Competence and innovation through own research, development and production.
- Global presence and active sales service in over 100 countries.
- Qualified technical consulting for economical and compliant fastening solutions. Also on-site at the construction site requested.
- Training sessions, some with accreditation, at your premises or at the fischer academy.
- Design and construction software for demanding applications.

We take responsibility

Our active environment management policy means that we are helping to maintain an intact environment for our generation and for those that follow. The environment management policy at the Tumlingen site has been certified in line with DIN EN ISO 14001. It fills us with particular pride that in 2020 we have received the most important and largest award in Europe in the field of sustainability: the German Sustainability Award - category large companies. This was in recognition of our holistic approach and the strategic anchoring of our sustainability management. With our greenline products we have launched the first range of fixings on the market that is based on renewable raw materials to more than 50%.



 German Sustainability Award	 Plus X Award – Sustainability	 GreenLine assortment based on 50% regrowing raw materials
 German Green Brand Award	 Lean & Green Management Award	

1

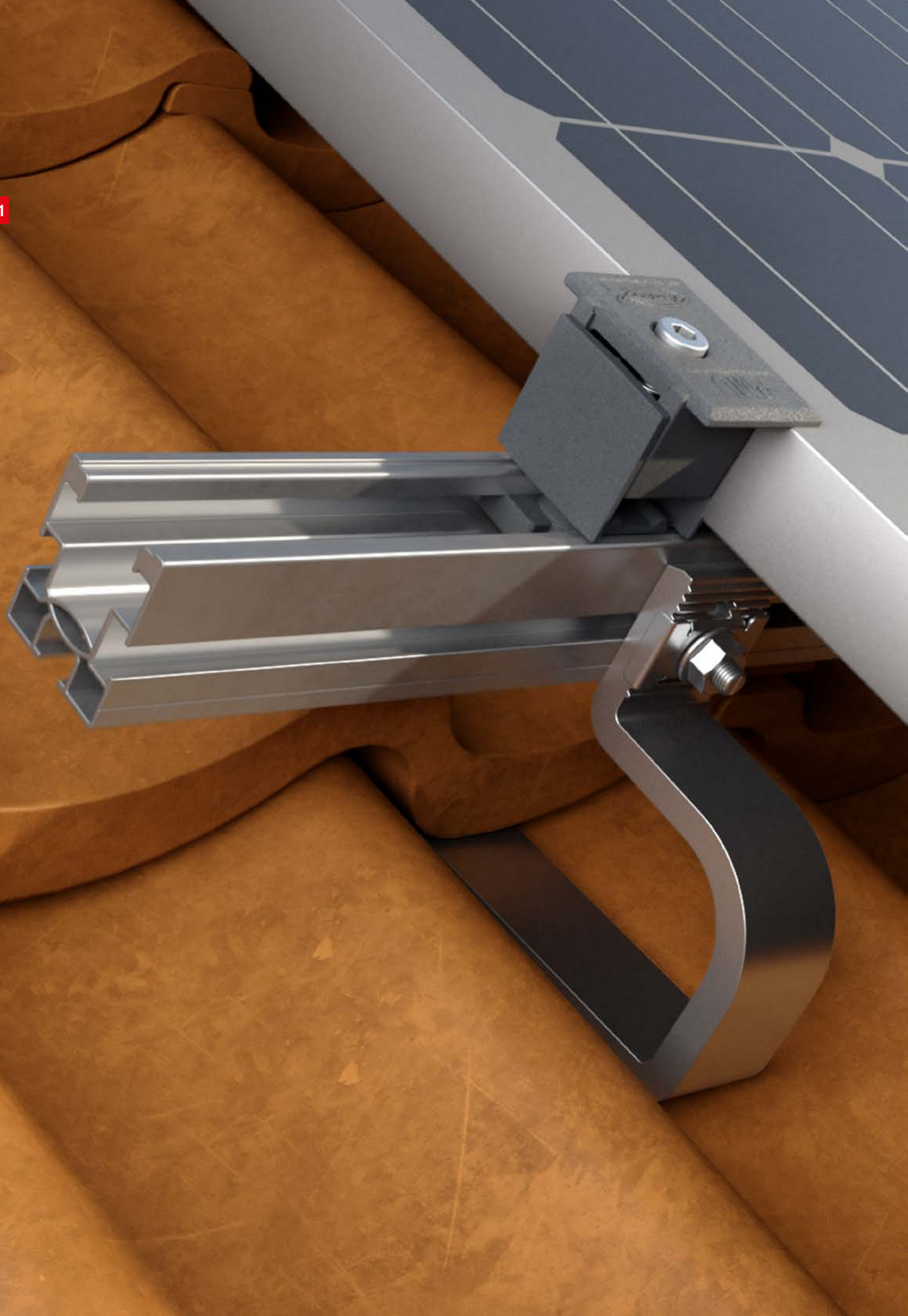

Content

Introduction	3	1
Clamps	15	2
Rails	29	3
Hooks	59	4
Stud screws	85	5
Triangles	99	6
Service	107	7

Mounting systems for pitched roofs.

1



Pitched roofs with tile or slate covering

The fischer range for fastening photovoltaic systems on pitched roofs with tiles or slates allows the installation of modules on roofs with or without ventilation strips, thanks to a complete range of hooks and screws.



Pitched roofs with corrugated sheets covering

The fischer fastening system with double thread screws with sealing gasket is ideal for photovoltaic installations on pitched roofs covered with corrugated sheets in different materials like fibre cement.



Pitched roofs with standing seam covering

The fischer system for photovoltaic installations on pitched roofs with standing seam covering involves the use of rails and clamps that guarantee the fastening of the panels both in portrait and landscape orientation.



Pitched roofs with trapezoidal metal sheets covering

The fischer mounting system for trapezoidal metal sheets covering is arranged into a full range of products to ensure the installation of photovoltaic panels on residential, commercial and industrial roofs.

Discover the new SOLARPANEL-FIX calculation software

SOLARPANEL-FIX is an Online module of the FIXperience Suite for the design of mounting systems for photovoltaic panels. It supports professionals in the design of the photovoltaic substructure through a clear and logical flow. The software allows to **automatically calculate the actions of snow and wind loads through the geolocation of the construction site**. In addition, it allows to download the bill of materials to create the substructure, the installation plan and a technical report.

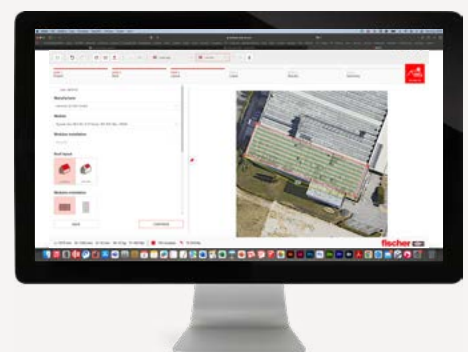

Mounting systems for flat and special roofs.



Triangles structures for flat roofs

This system provides fast and long lasting installations thanks to a range of products for low load bearability roofs.



Steel systems for flat roofs

The fischer mounting system for photovoltaic panels with steel profiles allows to create customized structures of any extension and slope.



Customized solutions for special roof shapes

The aluminium customizable system for photovoltaic panels allows to create structures adaptable to any type of roof shape.

The new SOLARPANEL-FIX design software for free.



Find out more information at <https://software.solar-fix.com>

Assortment overview.

1

Hooks

Hooks in aluminium and steel, available in fixed and adjustable variants, for fastening and supporting photovoltaic and solar systems on pitched roofs.



RH AL
Aluminium hook with fixed base for the installation of PV panels on pitched tile roofs without ventilation layer.



RH V AL / RH H AL
Aluminium hook with thin base for the installation of PV panels on pitched roofs with ventilation layer of variable thickness.

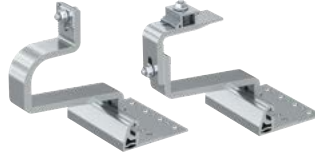

RH VB AL / RH HB AL
Aluminium hook with 3 adjustment positions for the installation of PV systems on tiled roofs with ventilation strips of variable thickness.



LAB AL
Angle connection bracket for the installation of landscape oriented PV panels on pitched roofs with tiles.

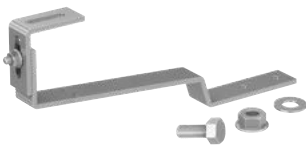

GTPR
Stainless steel hook for building structures for PV systems on roof tiles with a total thickness of up to 30 mm without ventilation strip.



GT
Stainless steel hook ideal to engage the load-bearing part of the support in case of discontinuous structures.



DLA
Stainless steel hook for building structures for PV systems on standing seam roofs. Suitable for flat seaming.



DLAK
Stainless steel hook for building structures for PV systems on standing seam roofs. Suitable for Kalzip standing seam.

Rails

High-performance universal aluminium rails for photovoltaic installations.



SolarLight
33 mm high aluminium rail for mounting systems for PV panels, particularly suitable for building structures on pitched roofs with supporting points close to each other.

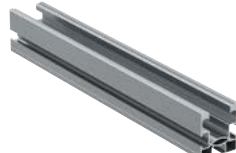

SolarFish
Aluminium rail for building structures for PV systems. The 44 mm high cross-section makes it particularly versatile for systems to be built on both flat and pitched roofs.



SolarMid
Aluminium rail with increased 83 mm high cross-section that makes it particularly suitable to optimize the number of supports to the roof in case of heavy stress forces acting.



SolarMetal
Aluminium rail for building structures for PV systems on trapezoidal metal sheet roofs. The section is optimised for allowing the landscape layout of the panels.



SolarFlat
Aluminium rail designed to allow PV systems on flat or sloping roofs with trapezoidal metal sheets and with orthogonal fastening.

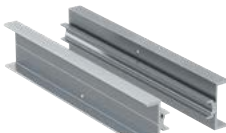

CPN AL
Compatible with SolarLight, SolarFish and SolarMid rails, this joint allows to connect two rails making them work together.



PXC
Aluminium bracket that allows to connect two overlapping Solar rails with an angle of 90° to create a crossed subframe.

Clamps

Universal and pre-assembled clamps in aluminium for PV modules of various thicknesses.

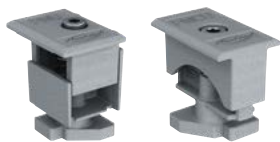

PM U - PMC U

The universal clamp for PV panels from 30 to 50 mm thickness, which can be used both as central clamp or end clamp.

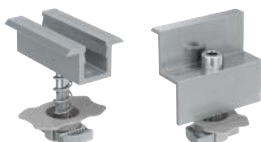

PM

Pre-assembled clamp for PV panels with aluminium frame. Available in different variants depending on the thickness of the PV panel.



M

Non-assembled clamp, available in different variants depending on the thickness of the PV panel.



MG

Non-assembled clamp for fastening frameless glass PV panels. Available in different lengths and in two thickness variants.

Double-threaded screws

Double-threaded screws with sealing gasket.



STSI

Double-threaded screw for fastening PV systems on corrugated panel or faux-barrel tile roofs with a steel load-bearing structure.



STSR

Double-threaded screw for PV installations on corrugated panel roofs with a wooden or fibre cement load-bearing structure.



MW

Angle brackets in stainless steel for the connection of the double-threaded screws with the Solar rails or for the connection of two overlapping Solar rails crossed at 90°.



SSP-SSP SPEED

Flat brackets for connecting Solar rails. Both SSP and SSP SPEED are available respectively in two variants with hole for M10 bars or with hole for M12 bars.

Triangles

Pre-assembled triangular frames with variable inclination for fastening PV modules, with either horizontal or vertical layout.



STFS

Compact triangular frame for installing PV systems in a lowered position on flat roofs with panels arranged in a landscape layout.



















STFN









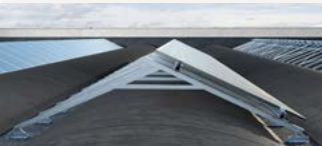





Triangular frame for flat roofs, suitable also for large PV panels with both portrait and landscape layout.

Selection guide

for your perfect system.

1





	Hooks								Triangles	
	RH AL	RH V AL / RH H AL	RH VB AL / RH HB AL	LAB AL	GTPR	GT	DLA	DLAK	STFS	STFN
Roofs										
 Pitched roof with tiles or slate covering	•	•	•	•	•	•	-	-	-	-
 Pitched roofs with corrugated sheets covering	-	-	-	-	-	-	-	-	-	-
 Pitched roofs with standing seam covering	-	-	-	-	-	-	•	•	-	-
 Pitched roofs with trapezoidal metal sheets covering	-	-	-	-	-	-	-	-	-	-
 Triangles structures for flat roofs	-	-	-	-	-	-	-	-	•	•
 Steel systems for flat roofs	-	-	-	-	-	-	-	-	-	-
 Custom solutions for special shapes	-	-	-	-	-	-	-	-	-	-

Rails							Clamps				Double-threaded screws			
SolarLight	SolarFish	SolarMid	SolarMetal	SolarFlat	CPN AL	PXC	PM U - PMC U	PM	M	MG	STSI	STSR	MW	SSP
														
•	•	-	-	-	•	•	•	•	•	•	•	•	-	-
•	•	-	-	-	•	•	•	•	•	•	•	•	•	•
•	•	-	-	-	•	•	•	•	•	•	-	-	•	-
-	-	-	•	•	-	•	•	•	•	•	•	•	•	•
-	•	-	-	-	-	-	•	•	•	•	-	-	-	-
-	-	-	-	-	-	-	•	•	-	-	-	-	-	-
-	-	•	-	-	-	•	•	•	•	•	-	-	•	•



2

Clamps

Pre-assembled adjustable clamps PM U and PMC U	16	
Pre-assembled clamp PM	19	
Non-assembled clamp M	22	
Clamp MG for glass PV panels	25	

Pre-assembled clamps PM U and PMC U

Universal adjustable clamps for PV panels with aluminium frame from 30 to 50 mm thickness.

2



Pitched roof with tiles



Roof with trapezoidal metal sheets covering

Applications

Framed PV panels fastening on Solar rails.

Certificates



Advantages

- Universal clamps fit all framed PV panels from 30 mm to 50 mm thickness.
- PM U pre-assembled universal clamp is suitable both for end or central use.
- PMC U is the version specific for central use only. Its reduced width allows to optimize rail consumption.
- PM U - PMC U clamps can be quickly installed at any point on the rail just by a rotation of 45°.
- Countersunk head screw avoids shadowing on adjacent PV panels.
- Thanks to the embedded spring, the PM U - PMC U pre-assembled universal clamps stay raised before the fastening, making the PV panels positioning phase easier.
- Ready to install.
- Available also in black anodized version.

Properties

- Clamp in EN AB 46100 aluminium alloy in accordance with EN 755-2:2013.
- A2-70 stainless steel Allen screw in accordance with EN ISO 3506-1/2:2009.

Functioning

- Insert the embedded hammer head nut of the PM U - PMC U pre-assembled universal clamps into the upper side of the rail.
- Turn the PM U universal clamp clockwise to use it as end clamp. Turn it anticlockwise to use it as a central clamp.
- Turn the PMC U universal clamp clockwise.
- Place the PM U - PMC U clamps in contact with the PV panels frame.
- Lock the PV panels in position by tightening the clamp screw with a 10 Nm torque.

Installation universal clamp PM U usage as end clamp

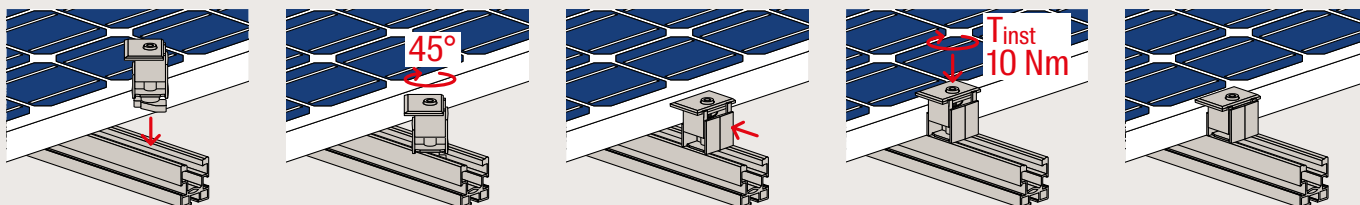

Installation universal clamp PM C U for central use only

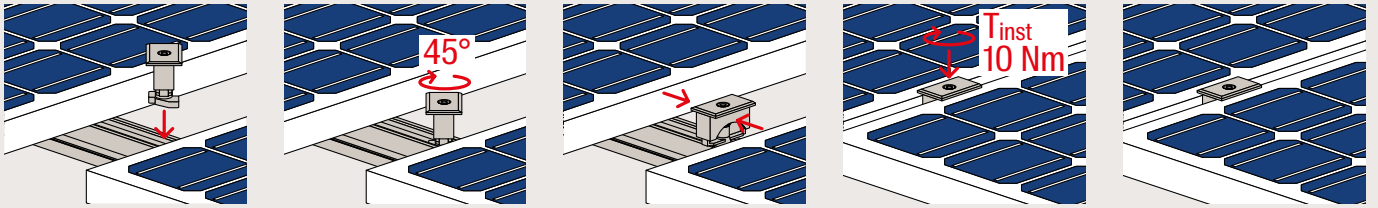

2

Installation universal clamp PM U usage as central clamp

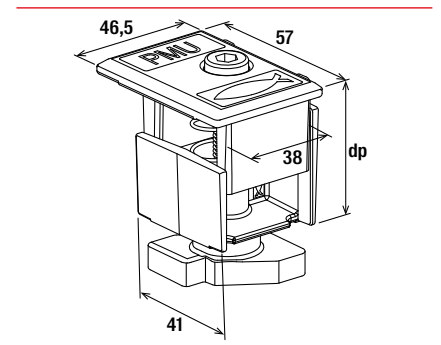
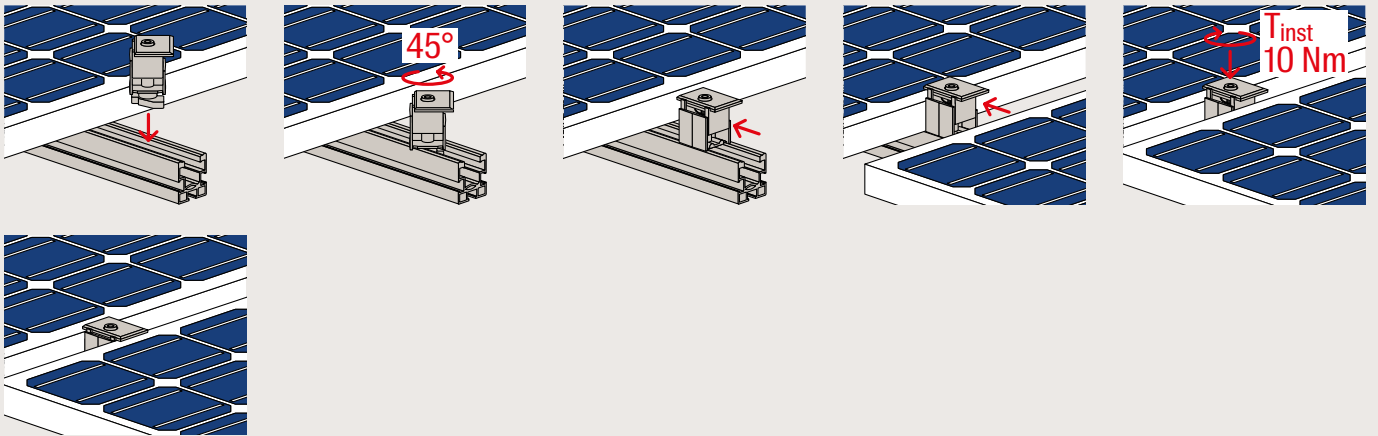

Technical data

Pre-assembled adjustable clamp PM U

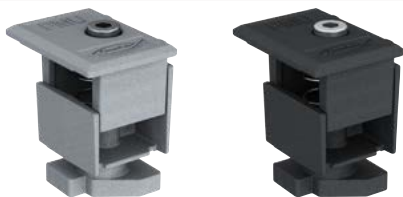

PM U

PM U black

Item	Item no.	Weight	Module thickness	Clamp size	Thread	Installation torque	Width across nut (hexagon socket)	Sales unit
		[g]	d_p [mm]	[mm]	M	T_{inst} [Nm]	SW [mm]	[pcs]
PM U 30 - 50 AL	519784	120	30 - 50	38 x 41	M8	10	6	10
PM U 30 - 50 AL black	534352	120	30 - 50	38 x 41	M8	10	6	10

· Clamp size: In case of PM U universal clamp end used consider 38 mm; in case of PM U universal clamp central used consider 41 mm.

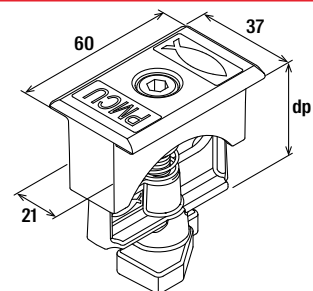

Technical data

Pre-assembled adjustable clamp PM C U



PM C U

PM C U black

Item	Item no.	Weight	Module thickness	Clamp size	Thread	Installation torque	Width across nut (hexagon socket)	Sales unit
		[g]	d_p [mm]	[mm]	M	T_{inst} [Nm]	SW [mm]	[pcs]
PM C U 30 - 50 AL	538880	120	30 - 50	21 x 60	M8	10	6	10
PM C U 30 - 50 AL black	538881	120	30 - 50	21 x 60	M8	10	6	10

Pre-assembled clamp PM

Pre-assembled central and end clamps for PV panels with aluminium frame.



Pitched roof with standing seam covering



Roof with trapezoidal metal sheet covering

Applications

Framed PV panels fastening on Solar rails, compatible with SolarFish, SolarFlat, SolarMetal.

Certificates



Advantages

- Thanks to the spring, the PM pre-assembled clamps stay raised before the fastening, making the PV panels positioning phase easier.
- Ready to install.
- Available also in black anodized version.

Properties

- PM C and PM F clamps in AW 6060 T66 aluminium alloy in accordance with EN 755-2:2013.
- A2.70 stainless steel Allen screw in accordance with EN ISO 3506-1 /2:2009.
- FCN AL hammer head nut in AW 6060 T66 aluminium alloy in accordance with EN 755-2:2013 and grey nylon PA6.

Functioning

- Identify the PV panel thickness and choose the suitable clamp.
- Insert the hammer head nut of the PM pre-assembled clamp into the rail and turn it 90° clockwise.
- Place the PV panels in position.
- Tighten the screw applying a 12 Nm torque.

Installation end clamp PM F

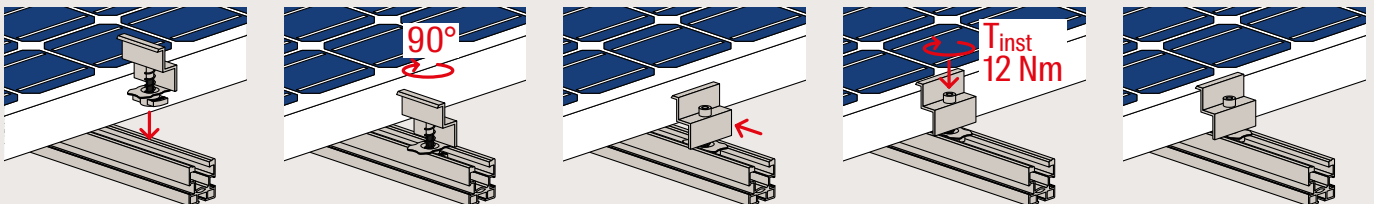

Installation central clamp PM C

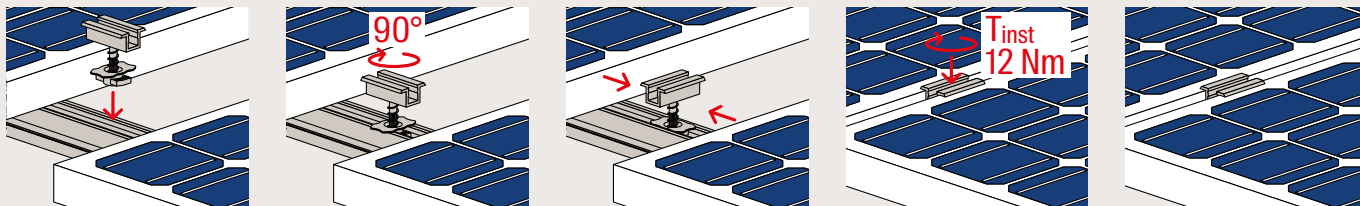

2

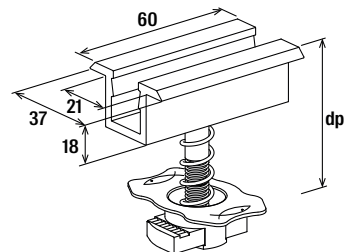

Technical data

Clamp PM C

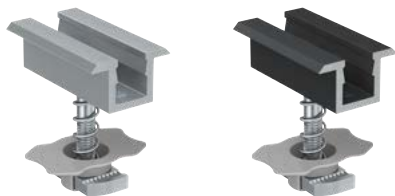

PM C

PM C black

Item	Item no.	Weight	Module thickness	Clamp size	Thread	Installation torque	Width across nut (hexagon socket) SW	Sales unit
		[g]	d_p [mm]	[mm]	M	T_{inst} [Nm]	[mm]	[pcs]
PM C 28 - 34 AL	511093	75	28 - 34	21 x 60	M8	12	6	10
PM C 28 - 34 AL black	561722	75	28 - 34	21 x 60	M8	12	6	10
PM C 33 - 39 AL	571214	75	33 - 39	21 x 60	M8	12	6	10
PM C 33 - 39 AL black	520112	75	33 - 39	21 x 60	M8	12	6	10
PM C 38 - 44 AL	571215	75	38 - 44	21 x 60	M8	12	6	10
PM C 43 - 49 AL	571216	75	43 - 49	21 x 60	M8	12	6	10
PM C 48 - 54 AL	571217	75	48 - 54	21 x 60	M8	12	6	10

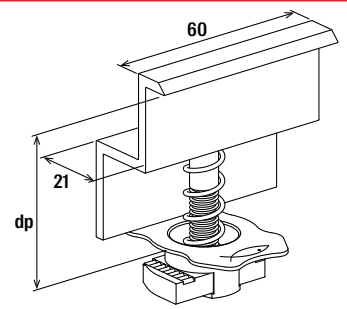

Technical data

Clamp PM F



PM F

PM F black

Item	Item no.	Weight	Module thickness	Clamp size	Thread	Installation torque	Width across nut (hexagon socket) SW	Sales unit
		[g]	d_p [mm]	[mm]	M	T_{inst} [Nm]	[mm]	[pcs]
PM F 28 AL	570767	75	28	21 x 60	M8	12	6	10
PM F 30 AL	554786	75	30	21 x 60	M8	12	6	10
PM F 30 AL black	564390	75	30	21 x 60	M8	12	6	10
PM F 31 AL	511092	75	31	21 x 60	M8	12	6	10
PM F 31 AL black	523670	75	31	21 x 60	M8	12	6	10
PM F 33 AL	534121	75	33	21 x 60	M8	12	6	10
PM F 34 AL	571218	75	34	21 x 60	M8	12	6	10
PM F 35 AL	571219	75	35	21 x 60	M8	12	6	10
PM F 35 AL black	520113	75	35	21 x 60	M8	12	6	10
PM F 36 AL	571220	75	36	21 x 60	M8	12	6	10
PM F 38 AL	571221	75	38	21 x 60	M8	12	6	10
PM F 40 AL	571222	75	40	21 x 60	M8	12	6	10
PM F 40 AL black	513854	75	40	21 x 60	M8	12	6	10
PM F 42 AL	571223	75	42	21 x 60	M8	12	6	10
PM F 45 AL	071725	75	45	21 x 60	M8	12	6	10
PM F 46 AL	071224	75	46	21 x 60	M8	12	6	10
PM F 50 AL	071225	75	50	21 x 60	M8	12	6	10

Non-assembled clamp M

Non-assembled central and end aluminium clamps for PV panels with aluminium frame.

2



Pitched roof with standing seam covering



Roof with trapezoidal metal sheet covering

Applications

Framed PV panels fastening on Solar rails, compatible with SolarFish, SolarFlat, SolarMetal.

Advantages

- Available in different sizes.

Properties

AW 6060 T66 aluminium alloy clamps in accordance with EN 755-2:2013.

Certificates



Functioning

- Identify the PV panel thickness and choose the suitable clamp.
- Assemble the clamp with the correct screw and the FCN hammer head nut.
- Insert the hammer head nut in the aluminium rail and turn it 90° clockwise.
- Place the PV panels in position.
- Tighten the screw applying a 12 Nm torque.

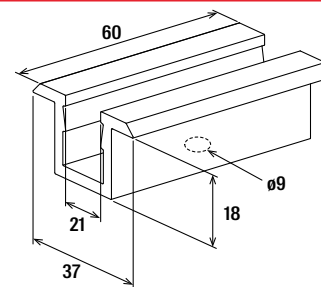

Technical data

Non-assembled clamp M C



M C

Item	Item no.	Weight [g]	Module thickness d_p [mm]	Screw length l_s [mm]	Clamp size [mm]	Thread M	Installation torque T_{inst} [Nm]	Sales unit [pcs]
M C 28-56 AL	571134	36	28 - 56	35 - 55	21 x 60	M8	12	10

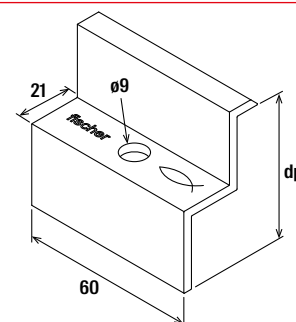

Technical data

Non-assembled clamp M F



M F

Item	Item no.	Weight [g]	Module thickness d_p [mm]	Clamp size [mm]	Thread M	Screw length l_s [mm]	Installation torque T_{inst} [Nm]	Sales unit [pcs]
M F 28 AL	570768	38	28	21 x 60	M8	35	12	10
M F 30 AL	558454	38	30	21 x 60	M8	35	12	10
M F 34 AL	571122	38	34	21 x 60	M8	30	12	10
M F 35 AL	071123	38	35	21 x 60	M8	40	12	10
M F 36 AL	571124	38	36	21 x 60	M8	30	12	10
M F 38 AL	571125	38	38	21 x 60	M8	35	12	10
M F 40 AL	571126	38	40	21 x 60	M8	35	12	10
M F 42 AL	071127	38	42	21 x 60	M8	40	12	10
M F 45 AL	071129	38	45	21 x 60	M8	40	12	10
M F 46 AL	571130	38	46	21 x 60	M8	40	12	10
M F 50 AL	571132	38	50	21 x 60	M8	45	12	10

Accessories non-assembled clamp M

Accessories non-assembled clamp M

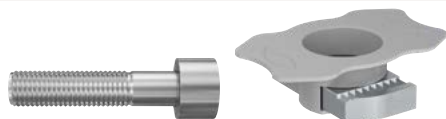

TCEI FCN AL

2

Item	Item no.	Thread M	Length l [mm]	Width across nut (hexagon socket) SW [mm]	Suitable for use with	Sales unit [pcs]
TCEI M8 x 35 A2	071277	M8	35	6	For 28-34 mm module thickness in combination with clamp MC	50
TCEI M8 x 40 A2	571139	M8	40	6	For 33-39 mm module thickness in combination with clamp MC	50
TCEI M8 x 45 A2	071278	M8	45	6	For 38-44 mm module thickness in combination with clamp MC	50
TCEI M8 x 50 A2	571140	M8	50	6	For 43-49 mm module thickness in combination with clamp MC	50
TCEI M8 x 55 A2	071286	M8	55	6	For 50-56 mm module thickness in combination with clamp MC	50
FCN AL M8	571165	M8	-	-	-	50

Clamp MG for glass PV panels

End and central clamps for frameless glass PV panels.

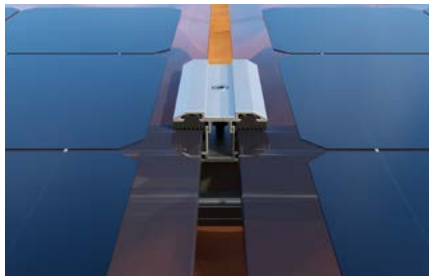

Frameless glass PV panels system

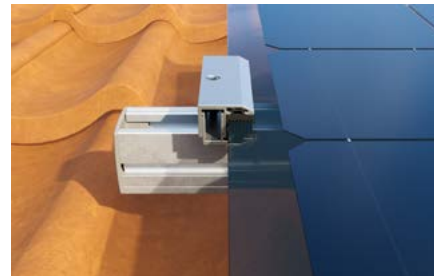

Frameless glass PV panels system

Applications

Glass framed PV panels fastening on Solar rails. Suitable for glass thicknesses from 5 mm to 8 mm.

Advantages

- Available in two variants to secure glass PV panels from 5 mm to 8 mm thickness and in different lengths to limit panel deflection.

Properties

AW 6060 T66 aluminium alloy MCG clamps in accordance with EN 755-2:2013.

Functioning

- Identify the MCG central and MFG end clamps depending on the brand of the PV panel manufacturer.
- Assemble the MCG central and MFG end clamps with the FCN AL hammer head nut using the Allen screw (TCEI).
- Insert the hammer head nut of the clamps thus assembled into the upper groove of the rail and turn it 90° clockwise.
- Lock the PV module by applying a tightening torque to the Allen screw of approximately 10 Nm.

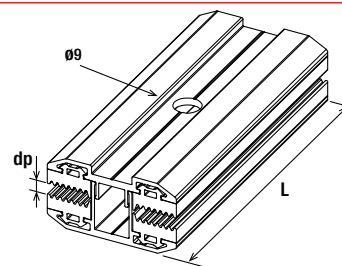

Technical data

Clamp MCG for glass PV panels



MCG

Item	Item no.	Module thickness d_p [mm]	Length l [mm]	For use with screw	Installation torque T_{inst} [Nm]	Sales unit [pcs]
MCG 80 5,0-6,2	536711	5.0 - 6.2	80	TCEI M8 x 40 A2	10	20
MCG 100 5,0-6,2	536712	5.0 - 6.2	100	TCEI M8 x 40 A2	10	20
MCG 120 5,0-6,2	536713	5.0 - 6.2	120	TCEI M8 x 40 A2	10	20
MCG 80 6,8-8,0	536707	6.8 - 8.0	80	TCEI M8 x 40 A2	10	20
MCG 100 6,8-8,0	536708	6.8 - 8.0	100	TCEI M8 x 40 A2	10	20
MCG 120 6,8-8,0	536709	6.8 - 8.0	120	TCEI M8 x 40 A2	10	20

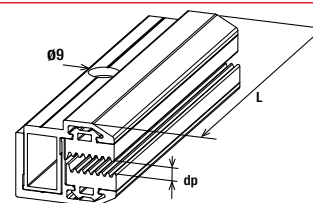

Technical data

Clamp MFG for glass PV panels



MFG

Item	Item no.	Module thickness d_p [mm]	Length l [mm]	For use with screw	Installation torque T_{inst} [Nm]	Sales unit [pcs]
MFG 80 5,0-6,2	536719	5.0 - 6.2	80	TCEI M8 x 40 A2	10	20
MFG 100 5,0-6,2	536720	5.0 - 6.2	100	TCEI M8 x 40 A2	10	20
MFG 120 5,0-6,2	536721	5.0 - 6.2	120	TCEI M8 x 40 A2	10	20
MFG 80 6,8-8,0	536715	6.8 - 8.0	80	TCEI M8 x 40 A2	10	20
MFG 100 6,8-8,0	536716	6.8 - 8.0	100	TCEI M8 x 40 A2	10	20
MFG 120 6,8-8,0	536717	6.8 - 8.0	120	TCEI M8 x 40 A2	10	20

Accessories clamp MG for glass PV panels

Accessories clamp MG for glass PV panels

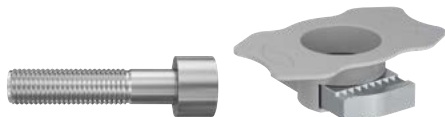

TCEI

FCN AL





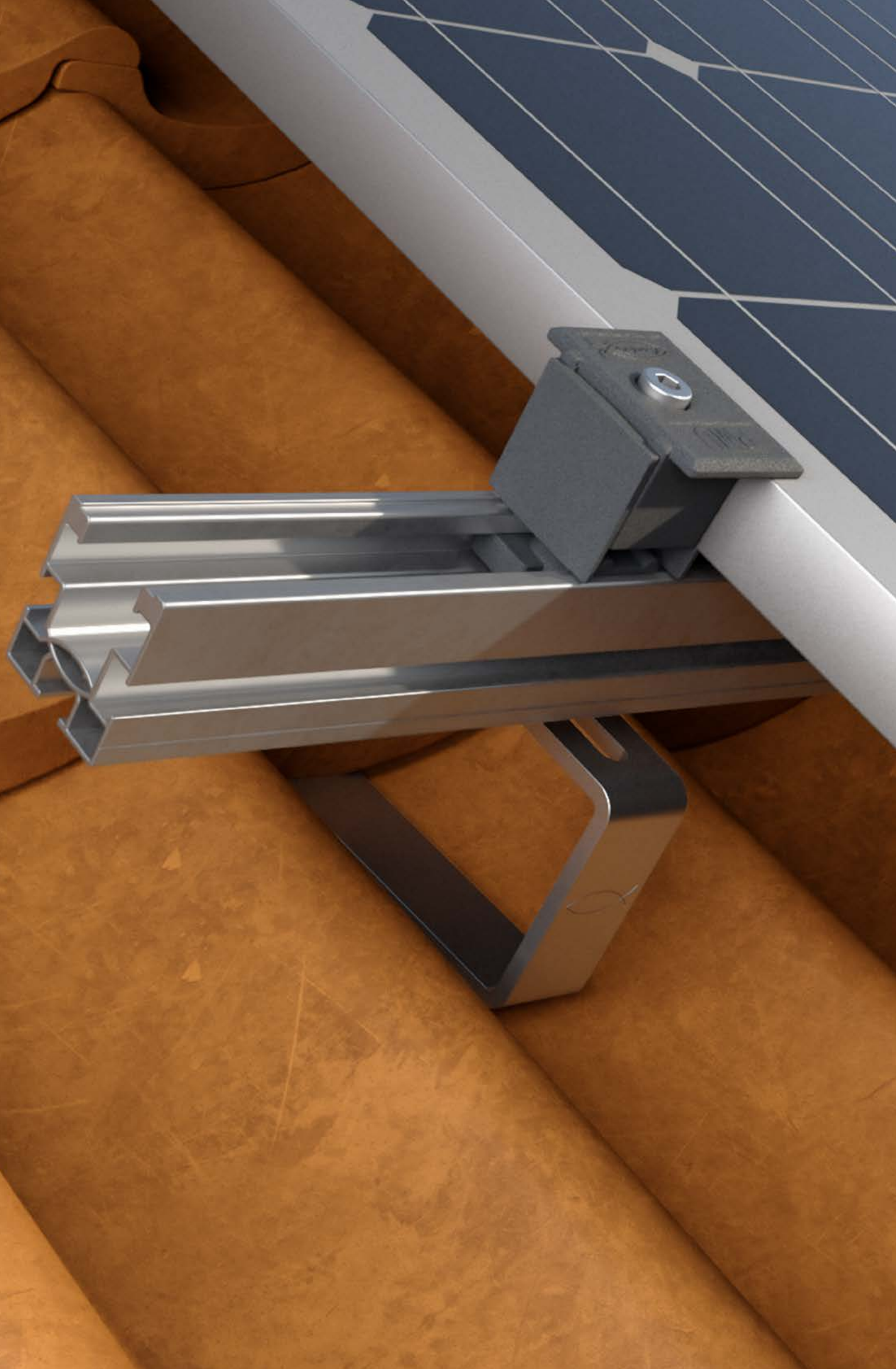





Item	Item no.	Thread M	Width across nut (hexagon socket) SW [mm]	Sales unit [pcs]
TCEI M8 x 40 A2	571139	M8	6	50
FCN AL M8	571165	M8	-	50

2



3

Rails

Rail SolarFish	30	
Rail SolarLight	33	
Rail SolarMid	35	
Rail SolarMetal	37	
Rail SolarFlat	42	
Rail TP AL	46	
Rail REP AL	49	
Bracing rail BP AL	52	
Rail connector CPN AL	54	
Connection bracket PXC AL	55	

Rail SolarFish

44 mm high aluminium rail for PV panels mounting systems.

3



Pitched roof with tiles



Flat roof

Applications

Aluminium rail for PV panels mounting systems suitable for the whole clamps range, in combination with tiles hooks, double-threaded screws, triangles and standing seam clamps.

Certificates



Advantages

- Different rails lengths optimized for different panels sizes.
- Compatible with installation both from the side and from the bottom.
- Compatible with SKS M8 hexagonal screws or RHS hammer head screws.
- Suitable for the quick couplings of the aluminium hooks.

Properties

Aluminium alloy AW 6063 T6 in accordance with EN 755-2:2013.

Functioning

- Identify the correct support components based on the type of roof (e.g. tile hooks, double threaded-screws, triangular frames, standing seam clamps, etc).
- Position the rail on the support components (use SOLARPANEL-FIX software to design the system).
- Use 1 CPN AL joint on both sides to connect the rails (a complete connection requires 2 CPN AL joints).
- Slide the CPN AL joint until the central stud touches the end side of the rail.
- Every CPN AL joint has to be connected to the rails with four 3.5 mm x 9.5 mm self-drilling screws (two screws per rail side).
- Consider a thermal break of at least 50 mm every 15 m.
- Position the PV panels and fasten the clamps.
- Apply the AK SP caps to the ends of the SolarFish rail.

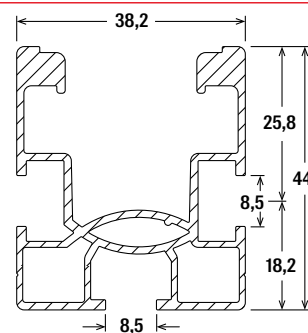

Technical data

Rail SolarFish

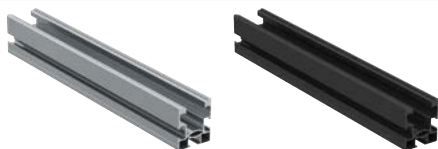

SolarFish

SolarFish black

Item	Item no.	Length l [mm]	Weight [kg/m]	Sales unit [pcs]
SolarFish 3,35 m AL	518645	3,350	0.9222	1
SolarFish 3.65 m AL	569371	3,650	0.9222	1
SolarFish 4.45 m AL	558358	4,450	0.9222	1
SolarFish 4.85 m AL	569372	4,850	0.9222	1
SolarFish 3.65 m AL black	570766 ¹⁾	3,650	0.9222	1

¹⁾ Rails available in black anodized version on request

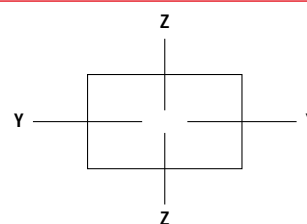

Loads

Item	Item no.	Rail cross section [cm ²]	Moment of inertia I _y [cm ⁴]	Moment of inertia I _z [cm ⁴]	Section modulus W _y [cm ³]	Section modulus W _z [cm ³]	Sales unit [pcs]
SolarFish 3,35 m AL	518645	3.42	7.27	6.45	3.26	3.37	1
SolarFish 3.65 m AL	569371	3.42	7.27	6.45	3.26	3.37	1
SolarFish 4.45 m AL	558358	3.42	7.27	6.45	3.26	3.37	1
SolarFish 4.85 m AL	569372	3.42	7.27	6.45	3.26	3.37	1
SolarFish 3.65 m AL black	570766 ¹⁾	3.42	7.27	6.45	3.26	3.37	1

¹⁾ Rails available in black anodized version on request

Accessories Rail SolarFish

Accessories Rail SolarFish

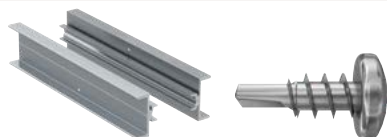

CPN AL Self-drilling screw 3,5x9,5

Item	Item no.	Weight	Sales unit
		[g]	[pcs]
CPN AL	514890	80	12
3.5 x 9.5 mm A2	571209	-	100

3

Accessories Rail SolarFish

Accessories Rail SolarFish



AK SP grey AK SP black

Item	Item no.	Weight	Colour	Piece per carton	Sales unit
		[g]		[pcs.]	[pcs]
AK SP grey	071183	7	grey	50	1
AK SP black	520909	7	black	80	8

Accessories

Accessories

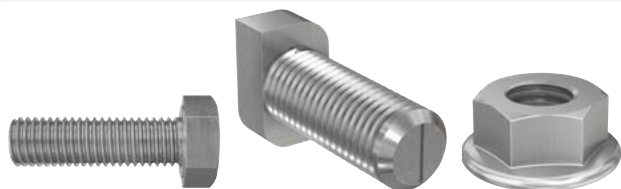

SKS RHS MU F

Item	Item no.	Thread	Length	Width across nut	Sales unit
		M	L [mm]	SW [mm]	[pcs]
SKS M8 x 20 mm A2	505614	M8	20	13	100
RHS 8.0 x 20 mm A2	071207	M8	20	13	50
MU F M8 A2	571210	M8	-	13	100

Rail SolarLight

33 mm high aluminium rail for PV panels mounting systems.



Pitched roof with tiles



Pitched roof with tiles

3

Applications

Aluminium rail for PV panels mounting systems with PM U and PMC U clamps in combination with tiles hooks, double-threaded screws, triangles and standing seam clamps.

Certificates



Advantages

- Compatible with installation both from the side and from the bottom.
- Compatible with SKS M8 hexagonal screws or RHS hammer head screws.
- Suitable for the quick couplings of the aluminium hooks.

Properties

Aluminium alloy AW 6063 T6 in accordance with EN 755-2:2013.

Functioning

- Identify the correct support components based on the type of roof (e.g. tile hooks, double threaded-screws, triangular frames, standing seam clamps, etc).
- Position the rail on the support components (use SOLARPANEL-FIX software to design the system).
- Use 1 CPN AL joint on both sides to connect the rails (a complete connection requires 2 CPN AL joints).
- Slide the CPN AL joint until the central stud touches the end side of the rail.
- Every CPN AL joint has to be connected to the rails with two 3.5 mm x 9.5 mm self-drilling screws (two screws per rail side).
- Consider a thermal break of at least 50 mm every 15 m.
- Position the PV panels and fasten the clamps.

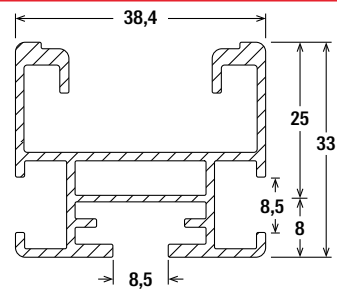

3 Technical data

Rail SolarLight



SolarLight

Item	Item no.	Length l [mm]	Weight [kg/m]	Sales unit [pcs]
SolarLight 3.65 m AL	569370	3,650	0.724	1

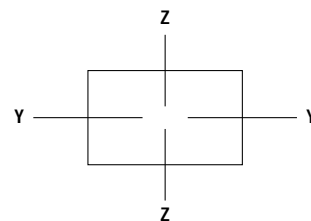

Loads

Item	Item no.	Rail cross section [cm ²]	Moment of inertia I _y [cm ⁴]	Moment of inertia I _z [cm ⁴]	Section modulus W _y [cm ³]	Section modulus W _z [cm ³]	Sales unit [pcs]
SolarLight 3.65 m AL	569370	2.68	3.07	4.76	1.70	2.48	1

Accessories rail SolarLight

Accessories rail SolarLight

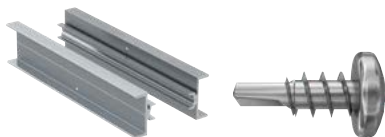

CPN AL Self-drilling screw 3,5x9,5

Item	Item no.	Weight [g]	Sales unit [pcs]
CPN AL	514890	80	12
3.5 x 9.5 mm A2	571209	-	100

Rail SolarMid

83 mm high aluminium rail for PV panels mounting systems.

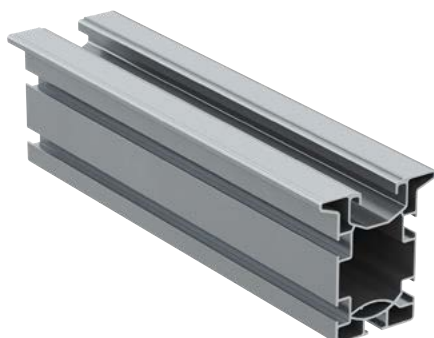

Special structure for flat roofs

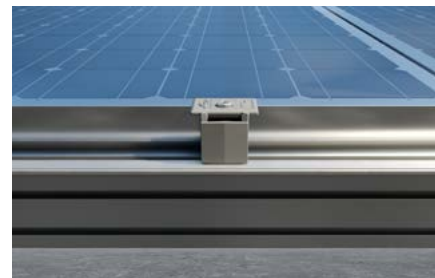

Flat roof

3

Applications

Aluminium rail for PV panels mounting systems compatible with PM U / PMC U universal clamps, in combination with triangles for flat roofs and rails for special structures.

Certificates



Advantages

- High load-bearing capacity.
- Two panels can be mounted on a single rail thanks to the wide top surface.
- Compatible with installation both from the side and from the bottom.
- Compatible with SKS M8 hexagonal screws or RHS hammer head screws.

Functioning

- Identify the correct support components based on the type of roof (e.g. triangular frames for flat roofs, rails for special structures etc).
- Position the selected support components and the rail according to the structure layout (use SOLARPANEL-FIX software to design the system).
- Use 2 CPN AL joints on both sides to connect the rails (a complete connection requires 4 CPN AL joints).
- Slide the CPN AL joint until the central stud touches the end side of the rail.
- Every CPN AL joint has to be connected to the rails with eight 3.5 mm x 9.5 mm self-drilling screws (two screws per rail side).
- Consider a thermal break of at least 50 mm every 15 m.
- Position the PV panels and fasten the clamps.

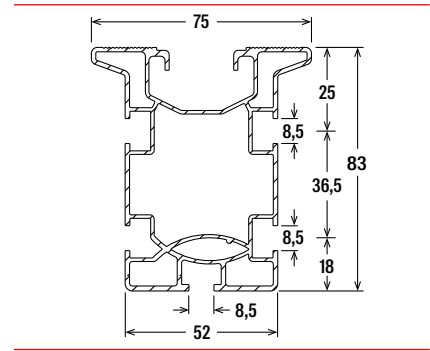

3

Technical data

Rail SolarMid



Item	Item no.	Length l [mm]	Weight [kg/m]	Sales unit [pcs]
SolarMid 4.85 m AL	569373	4,850	1.95	1

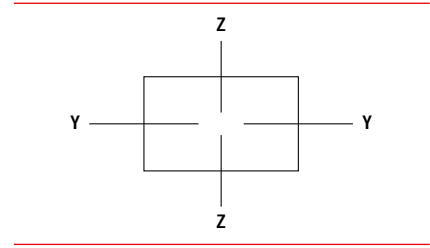

Loads

Item	Item no.	Rail cross section [cm ²]	Moment of inertia I _y [cm ⁴]	Moment of inertia I _z [cm ⁴]	Section modulus W _y [cm ³]	Section modulus W _z [cm ³]	Sales unit [pcs]
SolarMid 4.85 m AL	569373	7.22	62.89	29.98	14.94	11.53	1

Accessories rail SolarMid

Accessories rail SolarMid

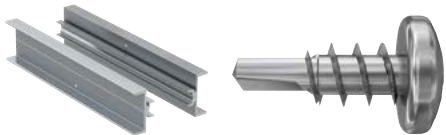

Item	Item no.	Sales unit [pcs]
CPN AL	514890	12
3.5 x 9.5 mm A2	571209	100

SolarMetal rail

Rail for photovoltaic systems on trapezoidal metal sheet roofs. Suitable for panels with landscape orientation.

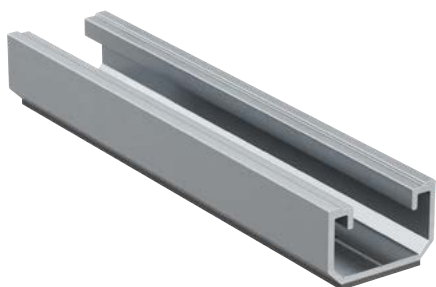

Roof with trapezoidal metal sheets covering



Roof with trapezoidal metal sheets covering

3

Applications

Installation of landscape oriented photovoltaic panels on trapezoidal sheet roofs.

Certificates



Advantages

- Complete range made of: long rails for an easy alignment and mounting during the installation; short rails for cost optimization and no issues related to thermal expansion.
- Short rails with pre-assembled EPDM on the bottom ready for the installation.
- Short rails are pre-drilled for installation with either ALG rivets or self-drilling screws.

Properties

- Aluminium alloy EN AW 6060 T66 in accordance with EN 755-2:2013.
- EPDM rubber gasket, 2 mm thick.

Functioning

- Choose between long rails and short rails depending on the installation layout and considering the thermal expansion.
- In case of long rails, determine the centre distance of the fastenings according to snow and wind loads (use SOLARPANEL-FIX software to design the system).
- In case of short rails apply a fastening on every hole.
- Only for long rails, stick a layer of CG INT butyl adhesive tape (minimum length 80 mm) on the trapezoidal metal sheet rib before applying and fastening the rail.
- Position the rail on the trapezoidal metal sheet.

For fastening with ALG rivets:

- Long rail: drill 5.5 mm both the rail and the metal sheet.
- Short rail: drill 5.5 mm the metal sheet.

For fastening with Solar screws:

- Long rail: drill 5.5 mm the rail and screw directly into the metal sheet;
- Short rail: screw through the pre-drilled holes.

Installation long rail SolarMetal with rivets

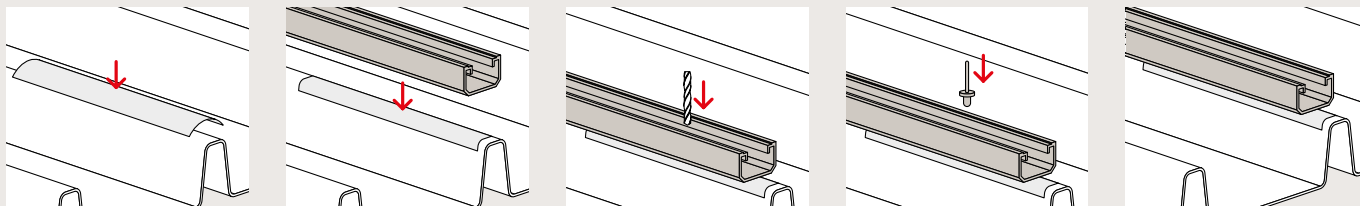

3

Installation long rail SolarMetal with screws

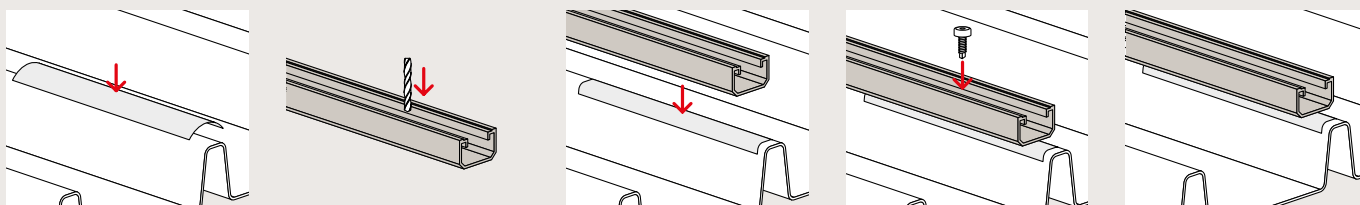

Installation short rail SolarMetal with rivets

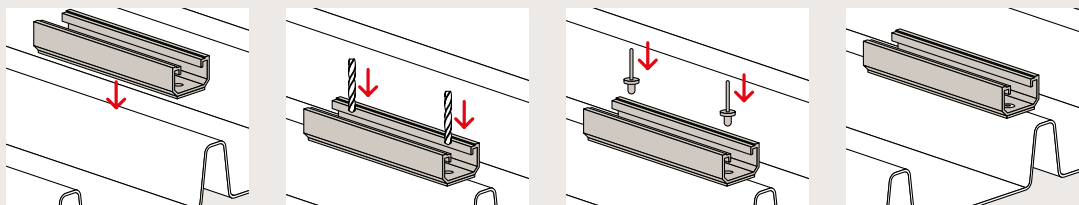

Installation short rail SolarMetal with screws

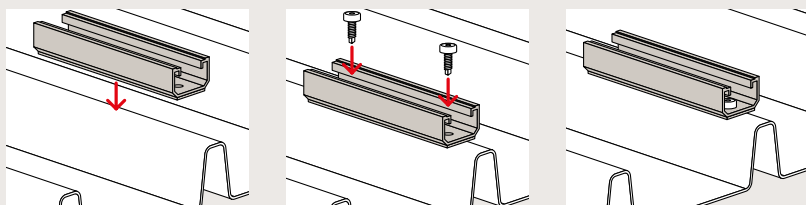

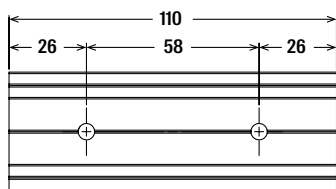

SolarMetal 110 mm

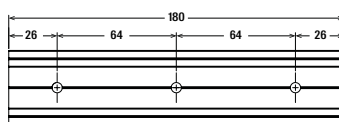

SolarMetal 180 mm

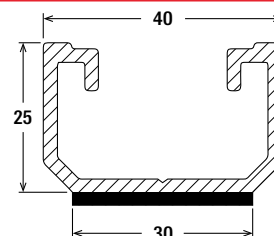

SolarMetal

Technical data

Rail SolarMetal



SolarMetal

Item	Item no.	Length l [mm]	Weight [kg/m]	Preamsembled EPDM	EPDM thickness	Number of drill holes	Hole- ϕ D [mm]	Sales unit [pcs]
SolarMetal 110 mm AL EPDM	567186	110	0.58	Yes	2.0	2	5.5	50
SolarMetal 180 mm AL EPDM	567187	180	0.58	Yes	2.0	3	5.5	50
SolarMetal 4.45 m AL	567412	4,450	0.58	No	-	-	-	1

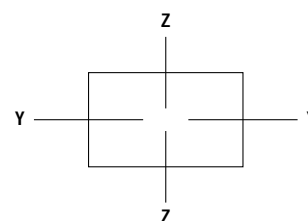

Loads

Item	Item no.	Rail cross section [cm ²]	Moment of inertia I_y [cm ⁴]	Moment of inertia I_z [cm ⁴]	Section modulus W_y [cm ³]	Section modulus W_z [cm ³]	Sales unit [pcs]
SolarMetal 110 mm AL EPDM	567186	216.64	1.70	5.00	1.30	2.50	50
SolarMetal 180 mm AL EPDM	567187	216.64	1.70	5.00	1.30	2.50	50
SolarMetal 4.45 m AL	567412	216.64	1.70	5.00	1.30	2.50	1

Accessories rail SolarMetal rivet ALG

Accessories rail SolarMetal rivet ALG



ALG

Item	Item no.	Diameter d [mm]	Hole- ϕ D [mm]	Steel sheet thickness s [mm]	Sales unit [pcs]
ALG 5.2 x 20 mm	545769	5.2	5.5	0.5 - 3.0	200

Loads

Loads rivet ALG



ALG

Item	Item no.	Recommended tensile load on aluminium sheet 0.5 mm [kN]	Recommended tensile load on aluminium sheet 0.6 mm [kN]	Recommended tensile load on aluminium sheet 1.0 mm [kN]	Recommended tensile load on steel sheet 0.5 mm [kN]	Recommended tensile load on steel sheet 0.6 mm [kN]	Recommended tensile load on steel sheet 1.0 mm [kN]	Sales unit [pcs]
ALG 5.2 x 20 mm	545769	0.30	0.36	0.66	0.54	0.60	0.66	200

- Loads suitable for aluminum sheets with a resistance of R_m min 200 N/mm² according to UNI EN 573.
- Loads suitable for steel sheets like the S355GD according to UNI EN 10346.

Accessories rail SolarMetal self-drilling screw

Accessories rail SolarMetal self-drilling screw



Item	Item no.	Diameter d [mm]	Hole- ϕ D [mm]	Length l [mm]	Steel sheet thickness s [mm]	Sales unit [pcs]
Screw 6,0 x 25 mm A2 EPDM	567188	6.0	5.5	25	0.5 - 1.0	100

Loads

Loads self-drilling screw



Item	Item no.	Recommended tensile load on aluminium sheet 0.5 mm [kN]	Recommended tensile load on aluminium sheet 0.6 mm [kN]	Recommended tensile load on aluminium sheet 1.0 mm [kN]	Recommended tensile load on steel sheet 0.5 mm [kN]	Recommended tensile load on steel sheet 0.6 mm [kN]	Recommended tensile load on steel sheet 1.0 mm [kN]	Sales unit [pcs]
Screw 6,0 x 25 mm A2 EPDM	567188	0.19	0.25	0.31	0.39	0.52	0.77	100

- Loads suitable for aluminum sheets with a resistance of R_m , min 165 N/mm² according to UNI EN 573.
- Loads suitable for stainless sheets like the S250GD according to UNI EN 10346.
- Recommended tightening torque for steel sheets is 3 Nm / aluminum sheets 1 Nm (reduce this figure up to 1 Nm on sheets with a thickness lower than 0.8 mm for steel sheets and 0.5 Nm for aluminium sheets).

Accessories rail SolarMetal butylene tape CG INT

Accessories rail SolarMetal butylene tape CG INT



CG INT

Item	Item no.	Length l [m]	Width B [mm]	Thickness S [mm]	Piece per carton [pcs.]	Sales unit [pcs]
CG INT	505615	10	80	1.0	2	1

3

Rail SolarFlat

Rail for photovoltaic systems on trapezoidal metal sheet roofs. Suitable for panels running along the long side parallel to the trapezoidal rails.

3



Roof with trapezoidal metal sheets covering



Roof with trapezoidal metal sheets covering

Applications

Installation of portrait oriented photovoltaic panels on trapezoidal sheet roofs.

Certificates



Advantages

- Complete range made of: long rails for an easy alignment and mounting during the installation; short rails for cost optimization and no issues related to thermal expansion.
- Flat and wide base allows 2 fixing points on each rib.
- Suitable for whole fischer clamps range.

Properties

Aluminium alloy AW 6060 T6 in accordance with EN 755-2:2013.

Functioning

- Choose between long rails and short rails depending on the installation layout and considering the thermal expansion.
- Determine the centre distance of the fastenings according to the trapezoidal metal sheet geometry, snow and wind loads (use SOLARPANEL-FIX software to design the system).
- Stick a layer of CG INT butyl adhesive tape (minimum length 80 mm) on the trapezoidal metal sheet rib before applying and fixing the rail.
- Position the rail on the trapezoidal metal sheet.
- In case of fastening with ALG rivets drill the rail and the sheet together with a 5.5 mm diameter bit.
- In case of fastening with EPDM self-drilling Solar Screw, pre-drill the rail in advance, then place it on the sheet and screw in the self-drilling screw through the pre-drilled hole.
- Seal rivets or screws with fischer SB - Bituminous Sealant.

Installation rail SolarFlat with rivets

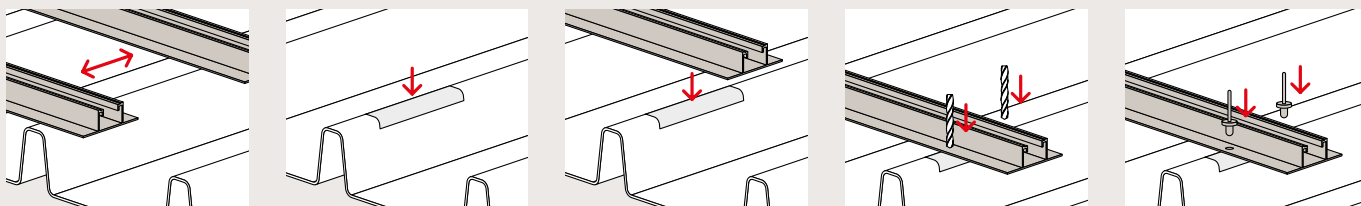

Installation rail SolarFlat with screws

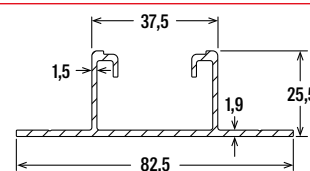
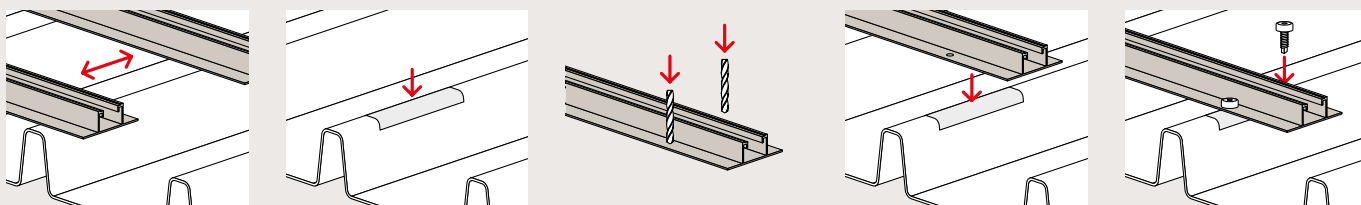

Technical data

Rail SolarFlat



SolarFlat

Item	Item no.	Length l [mm]	Weight [kg/m]	Sales unit [pcs]
SolarFlat P 400 mm AL	512195	400	0.724	50
SolarFlat 4.45 m AL	559873	4,450	0.724	1
SolarFlat 4.85 m AL	569374	4,850	0.724	1

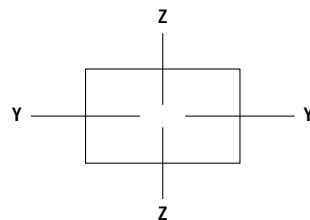

Loads

Item	Item no.	Rail cross section [cm ²]	Moment of inertia I _y [cm ⁴]	Moment of inertia I _z [cm ⁴]	Section modulus W _y [cm ³]	Section modulus W _z [cm ³]	Sales unit [pcs]
SolarFlat P 400 mm AL	512195	2.68	2.19	11.90	1.22	2.88	50
SolarFlat 4.45 m AL	559873	2.68	2.19	11.90	1.22	2.88	1
SolarFlat 4.85 m AL	569374	2.68	2.19	11.90	1.22	2.88	1

Rivet ALG

Rivet ALG



ALG

Item	Item no.	Diameter d [mm]	Drill diameter d ₀ [mm]	Steel sheet thickness s [mm]	Sales unit [pcs]
ALG 5.2 x 20 mm	545769	5.2	5.5	0.5 - 3.0	200

Loads

Loads rivet ALG



ALG

Item	Item no.	Recommended tensile load on aluminium sheet 0.5 mm [kN]	Recommended tensile load on aluminium sheet 0.6 mm [kN]	Recommended tensile load on aluminium sheet 1.0 mm [kN]	Recommended tensile load on steel sheet 0.5 mm [kN]	Recommended tensile load on steel sheet 0.6 mm [kN]	Recommended tensile load on steel sheet 1.0 mm [kN]	Sales unit [pcs]
ALG 5.2 x 20 mm	545769	0.30	0.36	0.66	0.54	0.60	0.66	200

- Loads suitable for aluminum sheets with a resistance of Rm min 200 N/mm² according to UNI EN 573.
- Loads suitable for steel sheets like the S355GD according to UNI EN 10346.

Self drilling screw EPDM

Self drilling screw EPDM



Item	Item no.	Diameter d [mm]	Length l [mm]	Sales unit [pcs]
Screw 6,0 x 25 mm A2 EPDM	567188	6.0	25	100

Loads

Loads self-drilling screw



Item	Item no.	Recommended tensile load on aluminium sheet 0.5 mm [kN]	Recommended tensile load on aluminium sheet 0.6 mm [kN]	Recommended tensile load on aluminium sheet 1.0 mm [kN]	Recommended tensile load on steel sheet 0.5 mm [kN]	Recommended tensile load on steel sheet 0.6 mm [kN]	Recommended tensile load on steel sheet 1.0 mm [kN]	Sales unit [pcs]
Screw 6,0 x 25 mm A2 EPDM	567188	0.19	0.25	0.31	0.39	0.52	0.77	100

- Loads suitable for aluminum sheets with a resistance of $R_{m,min}$ 165 N/mm² according to UNI EN 573.
- Loads suitable for stainless sheets like the S250GD according to UNI EN 10346.
- Recommended tightening torque for steel sheets is 3 Nm / aluminum sheets 1 Nm (reduce this figure up to 1 Nm on sheets with a thickness lower than 0.8 mm for steel sheets and 0.5 Nm for aluminium sheets).

Butylene tape CG INT

Butylene tape CG INT



CG INT

Item	Item no.	Length l [m]	Width B [mm]	Thickness S [mm]	Piece per carton [pcs.]	Sales unit [pcs]
CG INT	505615	10	80	1.0	2	1

Insights

Rail SolarFlat

- The right fastening layout depends on wind and snow load.
- Consider a proper thermal break between rails (10 mm minimum).
Always use two rivets, one on each side, on both ends of the rail.
- For the best layout and fastening use the SOLARPANEL-FIX software.
Install the system with an ambient temperature between 10° and 30 °C in order to limit the stresses due to the expansion of the rail.

Regarding the SolarFlat **long rails**, we particularly recommend:

- Maintain a distance of no less than 10 mm between the rails to avoid stresses due to contact between the ends caused by thermal expansion.
- Place the rivets either in an alternating layout, changing between the side of the rail for each rib, or in a double layout, with rivets on both sides of the rail for every second rib.
- Always use two rivets, one on each side, on the ends of the rail, also in case of fixing with alternating layout.

Regarding the SolarFlat **short rails**, we particularly recommend:

- Always fix the rail pieces with at least 4 rivets.
- Place the clamps in between the fixing points.

Rail TP AL

T-shaped aluminium rail for PV panels mounting systems on special structures.

3

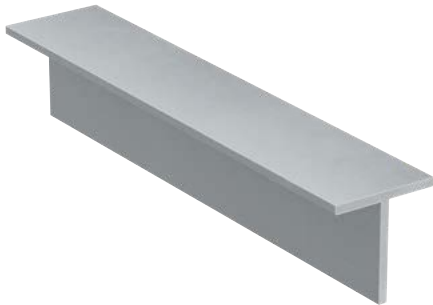

Special structure for flat roofs



Special structure for flat roofs

Applications

Aluminium rail for PV panels mounting systems suitable for special structures, in combination with REP AL and BP AL bracing rails.

Certificates



Advantages

- Optimized section for load-bearing structures.
- Easy to work (cut and drill).
- The wide top surface allows stable connection with other system components.

Properties

Aluminium alloy EN AW 6060 T5 in accordance with EN 755-2:2013.

Functioning

- Identify the correct support components based on the type of roof.
- Position the selected support components and the rail according to the structure layout (use SOLARPANEL-FIX software to design the system).
- Assemble the load-bearing structure with A2/A4 stainless steel SKS screws and MU F flanged nuts.
- Place the selected Solar rails on top of TP AL flat surface using A2/A4 M8 stainless steel SKS screws and MU F flanged nuts.

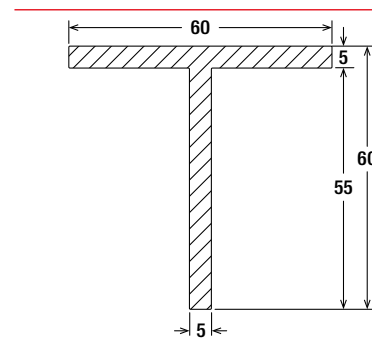

Technical data

Rail TP AL



TP AL

Item	Item no.	Length l [mm]	Weight [kg/m]	Sales unit [pcs]
TP AL 60 x60x5 mm - 6 mt	571185	6,000	1.55	1

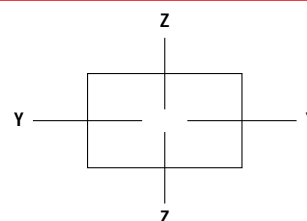

Loads

Item	Item no.	Rail cross section [cm ²]	Moment of inertia I _y [cm ⁴]	Moment of inertia I _z [cm ⁴]	Section modulus W _y [cm ³]	Section modulus W _z [cm ³]	Sales unit [pcs]
TP AL 60x60x5 mm - 6 mt	571185	5.75	19.90	9.05	11.85	3.02	1

Accessories hexagonal screw SKS A2

Accessories hexagonal screw SKS A2



SKS

Item	Item no.	Length L [mm]	Thread M	Width across nut SW [mm]	Sales unit [pcs]
SKS M8 x 20 mm A2	505614	20	M8	13	100
SKS M8 x 50 mm A2	571208	50	M8	13	100
SKS M10 x 50 mm A2	071181	50	M10	17	100
SKS M10 x 70 mm A2	071182	70	M10	17	100

Accessories flanged hexagon nut MU F A2

Accessories flanged hexagon nut MU F A2

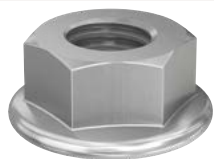

MU F

3

Item	Item no.	Thread M	Width across nut SW [mm]	Sales unit [pcs]
MU F M8 A2	571210	M8	13	100
MU F M10 A2	071952	M10	17	100

Rail REP AL

Rectangular hollow cross-section aluminium rail for PV panels mounting systems on special structures.

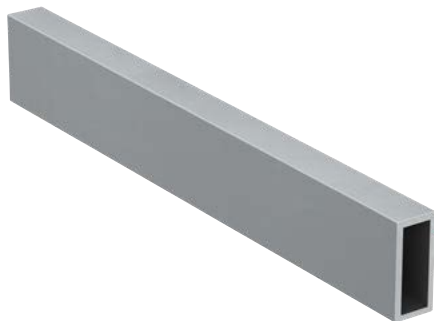

Special structure for flat roofs



Special structure for flat roofs

3

Applications

Aluminium rail for PV panels mounting systems suitable for special structures, in combination with TP AL and BP AL bracing rails.

Certificates



Advantages

- Optimized section for load-bearing structures.
- Easy to work (cut and drill).
- The wide lateral surface is a suitable connection point for other system components.

Properties

Aluminium alloy EN AW 6060 T5 in accordance with EN 755-2:2013.

Functioning

- Identify the correct support components based on the type of roof.
- Position the selected support components and the rail according to the structure layout (use SOLARPANEL-FIX software to design the system).
- Assemble the load-bearing structure with A2/A4 stainless steel SKS screws and MU F flanged nuts.

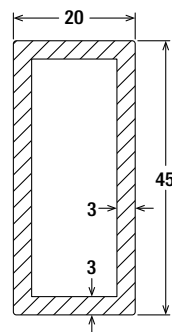

Technical data

Rail REP AL



REP AL

Item	Item no.	Length l [mm]	Weight [kg/m]	Sales unit [pcs]
REP AL 45x20x3 mm - 6 m	071186	6,000	0.95	1

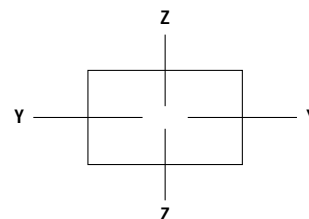

Loads

Item	Item no.	Rail cross section [cm ²]	Moment of inertia I _y [cm ⁴]	Moment of inertia I _z [cm ⁴]	Section modulus W _y [cm ³]	Section modulus W _z [cm ³]	Sales unit [pcs]
REP AL 45x20x3 mm - 6 m	071186	3.54	8.26	2.10	3.67	2.10	1

Accessories hexagonal screw SKS A2

Accessories hexagonal screw SKS A2



SKS

Item	Item no.	Length L [mm]	Thread M	Width across nut SW [mm]	Sales unit [pcs]
SKS M8 x 20 mm A2	505614	20	M8	13	100
SKS M8 x 50 mm A2	571208	50	M8	13	100
SKS M10 x 50 mm A2	071181	50	M10	17	100
SKS M10 x 70 mm A2	071182	70	M10	17	100

Accessories flanged hexagon nut MU F A2

Accessories flanged hexagon nut MU F A2

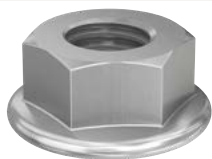

MU F

Item	Item no.	Thread M	Width across nut SW [mm]	Sales unit [pcs]
MU F M8 A2	571210	M8	13	100
MU F M10 A2	071952	M10	17	100

3

Bracing rail BP AL

Aluminium rail for bracing structures for photovoltaic systems.

3

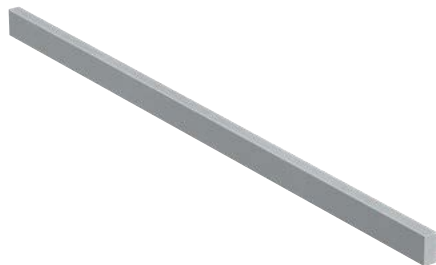

Flat roof



Mounting detail on a flat roof

Applications

Bracing of triangular frames for flat roofs or rails for special structures.

Advantages

- Fast installation with self-drilling screws.
- Reduced cross-section optimized for tension forces.

Properties

Aluminium alloy EN AW 6060 T5 in accordance with EN 755-2:2013.

Certificates



Functioning

- Define the geometry and the layout of the bracing rails depending on the structure (use SOLARPANEL-FIX software to design the system).
- Fasten the BP AL bracing rails with TE 4.8 x 32 mm self-drilling screws.

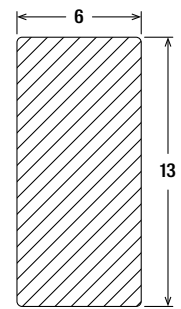

Technical data

Bracing profile BP AL



BP AL

Item	Item no.	Length l [mm]	Weight [kg/m]	Sales unit [pcs]
BP AL	071184	4,000	0.21	1

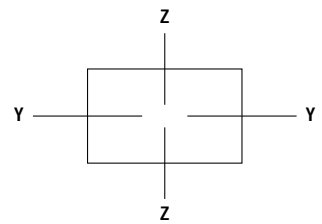

Loads

Item	Item no.	Rail cross section [cm ²]	Moment of inertia I _y [cm ⁴]	Moment of inertia I _z [cm ⁴]	Section modulus W _y [cm ³]	Section modulus W _z [cm ³]	Sales unit [pcs]
BP AL	071184	0.78	0.10	0.02	0.16	0.07	1

Accessories

Accessories

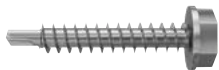

Self-drilling screw 4.8 x 32

Item	Item no.	Diameter d [mm]	Length l [mm]	Sales unit [pcs]
4.8 x 32 mm A2	071285	4.8	32	100

Rail connector CPN AL

Aluminium connector for two Solar rails.

3



Pitched roof with tiles



Flat roof

Applications

PV panels installation on pitched or flat roofs where a joint between two Solar rails is required.

Advantages

- Compatible with SolarLight rail, SolarFish rail, SolarMid rail.

Properties

AW 6005A T6 aluminium alloy in accordance with EN 755-2:2013.

Certificates



Functioning

- Use 1 CPN AL joint for each lateral groove of the rail.
- Slide the CPN AL joint until the central stud touches the end side of the rail.
- Connect the CPN AL joint to the rail with the right amount of 3.5 mm x 9.5 mm self-drilling screws (according to the selected rail).

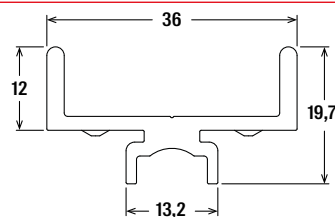

Technical data

Rail connector CPN AL



CPN AL

Item	Item no.	Length l [mm]	Sales unit [pcs]
CPN AL	514890	183	12

Connection bracket PXC AL

Bracket for 90° connection of two overlapping Solar rails.



Pitched roof with tiles



Flat roof

3

Applications

Cross connection of two overlapping Solar rails. Compatible with SolarFish and Solar-Mid rails.

Certificates



Advantages

- Fast installation of the Solar rail by tightening a single screw.
- The bracket is pre-assembled and ready to be mounted without the need for additional accessories.

Properties

- Connection bracket in AW6063 T6 aluminium alloy in accordance with EN 755-2:2013.
- A2-70 stainless steel Allen screw in accordance with EN ISO 3506-1/2;2009.
- FCN AL hammer head nut in AW 6060 T66 aluminium alloy in accordance with EN 755-2:2013 and grey nylon PA 6.

Functioning

- Insert the FCN AL M 8 nut (preassembled to the bracket) in the upper side of the lower Solar rail and rotate it by 90°.
- Insert the knurl of the bracket into the lateral side of the upper Solar rail.
- Tighten the hexagonal socket screw applying a 10 Nm torque to secure the connection.

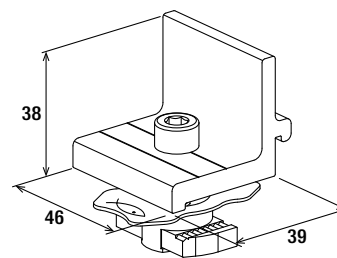

3 Technical data

Connection bracket PXC A







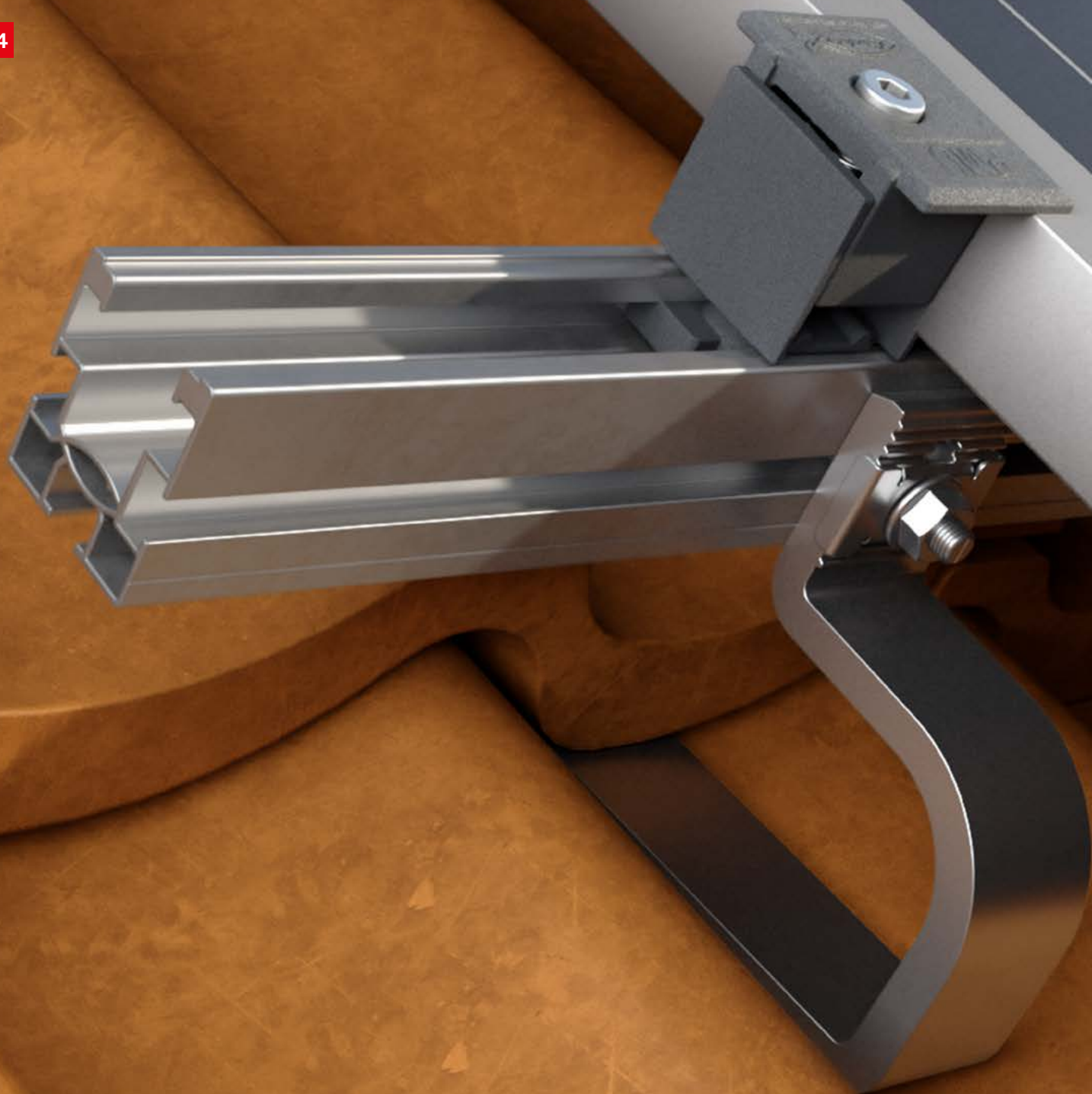





PXC AL

Item	Item no.	Weight [g]	Thread M	Screw length l_s [mm]	Width across nut (hexagon socket) SW [mm]	Installation torque T_{inst} [Nm]	Sales unit [pcs]
PXC AL	522671	65	M8	20	6	10	10



4

Hooks

Aluminium hooks with large base RH VB AL/RH HB AL	60	
Aluminium hooks with thin base RH V AL/RH H AL	63	
Aluminium hook with fixed base RH AL	66	
Stainless steel hook with large base RH HB A2	68	
Stainless steel hook with large base GT A2	70	
Stainless steel hook with thin base GTP A2	72	
Stainless steel hook with thin base GTPR A2	74	
Stainless steel hook for barrell tiles GC A2	76	
Stainless steel hook for flat standing seam DLA A2	78	
Stainless steel hook for rounded standing seam DLAK A2	80	
Bracket for landscape oriented PV panels LAB AL	82	

Hooks with large base RH VB AL/RH HB AL

Aluminium hooks with large base for the installation of PV panels on pitched tile roofs with ventilation layer of variable thickness. Horizontally-offsettable fastening point.

4



Pitched roof with tiles



Pitched roof with tiles

Applications

PV panels installation on pitched roofs with tiles with ventilation layers of various thicknesses.

Advantages

- Multiple adjustments to adapt the hook to different tiles and ventilation.
- The great load-bearing capacity allows the use of fewer hooks.
- The hook has a controlled deformation not to bend or damage the tiles.
- The hook is pre-assembled.

Properties

- Hook in aluminum alloy AW 6060 T6 and AW 6082 T6 in accordance with EN 2:2016.
- Class A2-70 stainless steel bolts in accordance with EN ISO 3506-1/2:2010.

Functioning

- Determine the system layout using SOLARPANEL-FIX software.
- Lift the tile and secure the base of the hook.
- Make the height and width adjustments and tighten the screws.
- Grind the upper tile and put it back in position.
- For RH HB AL versions: insert the upper joint on the side of the rail and adjust the rail position and fasten it.
- For RH VB AL versions: connect the Solar rail by inserting the pre-installed screw on the side of the rail and fasten it.
- For landscape oriented PV panels use the LAB bracket with RH VB AL versions.

Installation hook RH HB AL

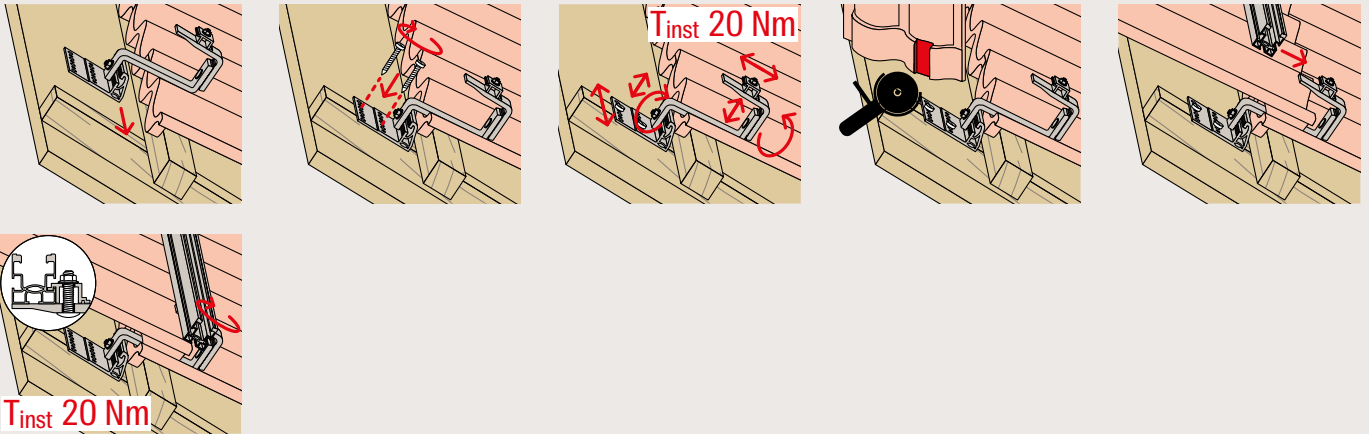

Installation hook RH VB AL

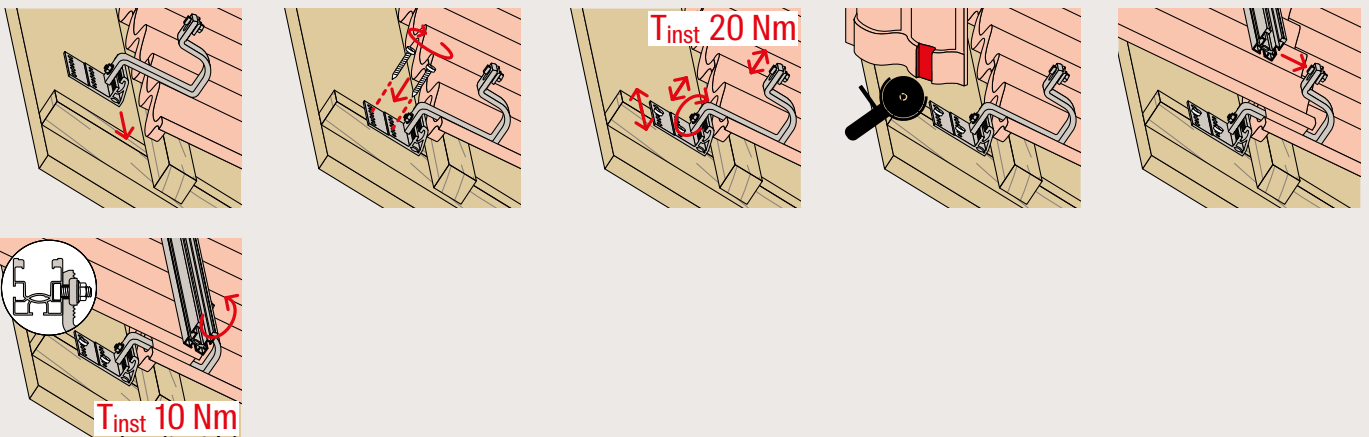

Insights

RH large base

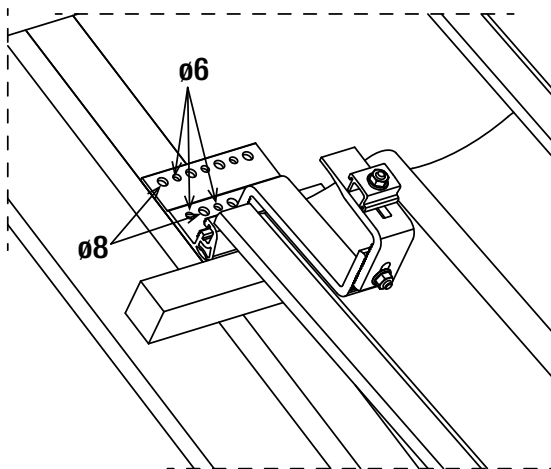

Recommended number and position of the fastening screws

Fasten the hook to the loadbearing structure using 2 x 8 mm diameter screws or 3 x 6 mm diameter screws

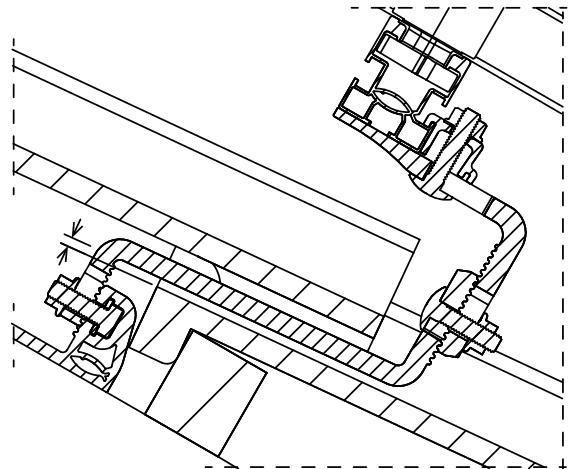

Recommended distance from the tile

Make sure of leaving an appropriate space between the lower side of the hook bracket and the tile (use the software SOLAR-PANEL-FIX to design the system).

Technical data

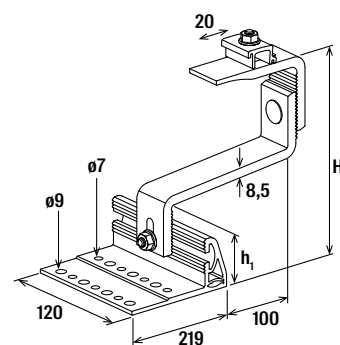

Aluminium hooks with large base RH HB AL



RH HB AL

Item	Item no.	Weight [kg]	Thickness S [mm]	Base plate width [mm]	Height under bracket h ₁ [mm]	Total height H [mm]	Depth [mm]	Width across nut SW [mm]	Installation torque T _{inst} [Nm]	Sales unit [pcs]
RH 40-52 HB AL	571745	0.61	8.5	120	40 - 52	119.5 - 149.5	100	13	20	10
RH 52-67 HB AL	571747	0.62	8.5	120	52 - 67	131 - 164	100	13	20	10

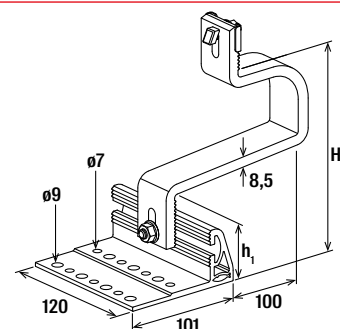

Technical data

Aluminium hooks with large base RH VB AL



RH VB AL

Item	Item no.	Weight [kg]	Thickness S [mm]	Base plate width [mm]	Height under bracket h ₁ [mm]	Total height H [mm]	Depth [mm]	Width across nut SW [mm]	Installation torque T _{inst} [Nm]	Sales unit [pcs]
RH 40-52 VB AL	571746	0.58	8.5	120	40 - 52	120 - 147	100	13	20	10
RH 52-67 VB AL	571748	0.6	8.5	120	52 - 67	132 - 162	100	13	20	10

The total height dimension is referred to the distance between the base of the hook and the lower side of the rail.

Hooks with thin base RH V AL/RH H AL

Aluminium hooks with thin base for the installation of PV panels on pitched tile roofs with ventilation layer of variable thickness.



Pitched roof with tiles



Pitched roof with tiles

4

Applications

PV panels installation on pitched roofs with tiles with ventilation layers of various thicknesses.

Advantages

- Multiple adjustments to adapt the hook to different tiles and ventilation.
- The great load-bearing capacity allows the use of fewer hooks.
- The hook has a controlled deformation not to bend or damage the tiles.
- The hook is pre-assembled.

Properties

- Hook in aluminum alloy AW 6060 T6 and AW 6082 T6 in accordance with EN 2:2016.
- Class A2-70 stainless steel bolts in accordance with EN ISO 3506-1/2:2010.

Functioning

- Determine the system layout using SOLARPANEL-FIX software.
- Lift the tile and secure the base of the hook.
- Make the height and width adjustments and tighten the screws.
- Grind the upper tile and put it back in position.
- For RH H AL versions: insert the upper joint on the side of the rail and adjust the rail position and fasten it.
- For RH V AL versions: connect the Solar rail by inserting the pre-installed screw on the side of the rail and fasten it.
- For landscape oriented PV panels use the LAB bracket with RH V AL versions.

Installation hook RH H AL

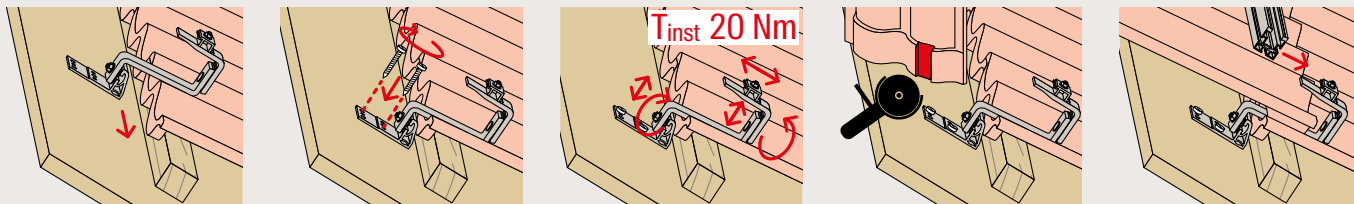

4

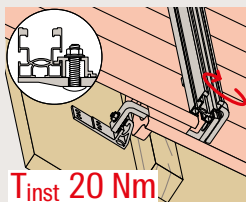

Installation hook RH V AL

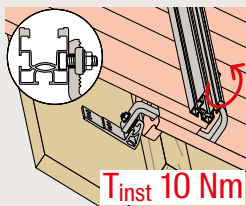
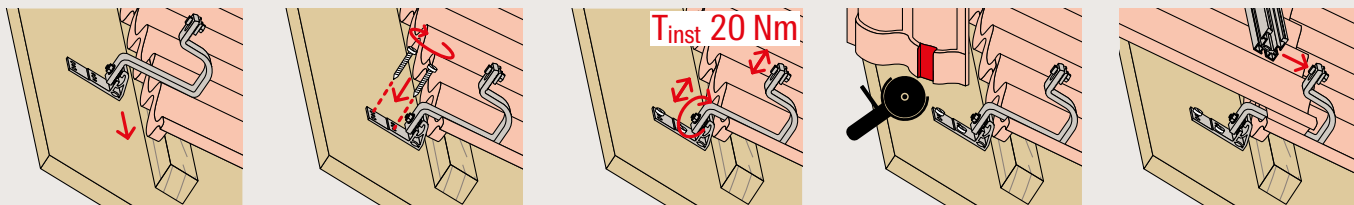

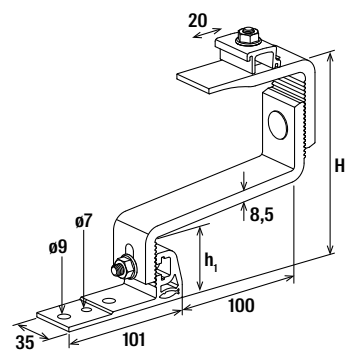

Technical data

Aluminium hooks with thin base RH H AL



RH H AL

Item	Item no.	Weight [kg]	Thickness S [mm]	Base plate width [mm]	Height under bracket h_1 [mm]	Total height H [mm]	Depth [mm]	Width across nut SW [mm]	Installation torque T_{inst} [Nm]	Sales unit [pcs]
RH 40-52 H AL	571742	0.42	8.5	35	40 - 52	119.5 - 149.5	100	13	20	10
RH 52-67 H AL	571744	0.43	8.5	35	52 - 67	131 - 164	100	13	20	10

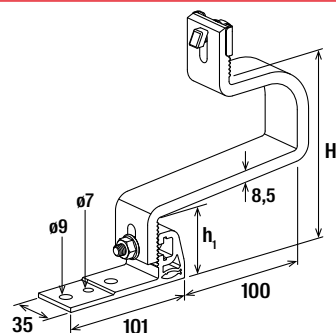

Technical data

Aluminium hooks with thin base RH V AL



RH V AL

Item	Item no.	Weight [kg]	Thickness S [mm]	Base plate width [mm]	Height under bracket h_1 [mm]	Total height H [mm]	Depth [mm]	Width across nut SW [mm]	Installation torque T_{inst} [Nm]	Sales unit [pcs]
RH 40-52 V AL	571741	0.4	8.5	35	40 - 52	120 - 147	100	13	20	10
RH 52-67 V AL	571743	0.4	8.5	35	52 - 67	132 - 162	100	13	20	10

The total height dimension is referred to the distance between the base of the hook and the lower side of the rail.

Aluminium hook with fixed base RH AL

Aluminium hook with fixed base for the installation of PV panels on pitched tile roofs without ventilation layer.

4

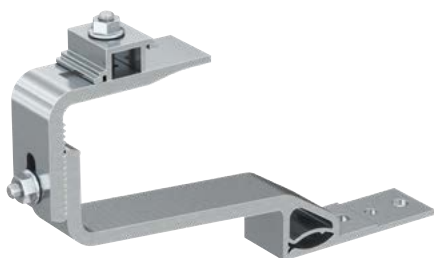

Pitched roof with tiles



Pitched roof with tiles

Applications

PV panels installation on pitched roofs with tiles without ventilation layer.

Advantages

- The multiple adjustments allow to adapt the hook to different tiles: the vertical adjustment allows to record the distance of the rail from the top of the tile; the higher adjustment allows to horizontally align the rail.
- The great load-bearing capacity allows the use of fewer hooks.
- The hook has a controlled deformation and it's designed not to bend or damage the tiles.
- The hook is pre-assembled and ready to be mounted without the need for additional accessories.
- The hook is lightweight and made of aluminium to last the entire life of the system.
- The quick connection joint can fit both with SolarLight and SolarFish rails by a 180° rotation.

Properties

Hook in aluminum alloy AW 6060 T6 and AW 6082 T6 in accordance with EN 2:2016.

Functioning

- Determine the centre distance of the hooks according to the snow and wind loads in the installation area (use SOLARPANEL-FIX software to design the system) and according to the load-bearing structure and system layout.
- Lift the tile and secure the base of the hook using the appropriate anchor determined according to the type and layers of the load-bearing support.
- Make the height adjustment required by the type of roofing and tighten the screws of the adjustment applying a 20Nm torque to lock the hook in position.
- Grind the upper tile to fit the hook shape and put it back in position.
- Insert the upper joint on the side of the selected rail and adjust the rail position (the joint can be rotated by 180° to adapt to SolarLight or SolarFish rails). Fasten the connection joint nut applying a 20 Nm torque.

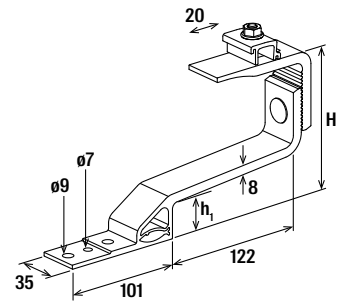

Technical data

Aluminium hook with fixed base RH H AL



RH H AL

Item	Item no.	Weight [kg]	Thickness S [mm]	Base plate width [mm]	Height under bracket h_1 [mm]	Total height H [mm]	Depth [mm]	Width across nut SW [mm]	Installation torque T_{inst} [Nm]	Sales unit [pcs]
RH 30 H AL	571749	0.33	8.0	35	30	106 - 124	122	13	20	10

Hook with large base RH HB A2

Stainless steel adjustable hook with large base for the installation of PV panels on pitched tile roofs with ventilation layer.

4



Pitched roof with tiles



Pitched roof with tiles

Applications

PV panels installation on pitched roofs with tiles with ventilation layer.

Advantages

- The multiple adjustments allow to adapt the hook to different tiles and ventilation layers: the horizontal base adjustment allows to offset the fastening point from the exit point of the hook from the tile; the lower vertical adjustment allows to adapt the hook to different thicknesses of tiles and ventilation layers; the upper vertical adjustment allows to record the distance of the rail from the top of the tile; the higher adjustment allows to horizontally align the rail.
- The 5 mm thickness allows a reduced tile grinding.
- Made of resistant stainless steel.
- The accessories for connecting to the Solar rails are included in the package.

Properties

- X5CrNi 18-10 stainless steel hook in accordance with EN 10088-2:2005.
- Class A2-70 stainless steel bolts in accordance with EN ISO 3506-1/2:2010.

Functioning

- Determine the centre distance of the hooks according to the snow and wind loads in the installation area (use SOLARPANEL-FIX software to design the system) and according to the load-bearing structure and system layout.
- Lift the tile and secure the base of the hook using the appropriate anchor determined according to the type and layers of the load-bearing support.
- Make the height and width adjustments required by the type of roofing and tighten the screws of the adjustments applying a 20 Nm torque to lock the hook in position.
- Grind the upper tile to fit the hook shape and put it back in position.
- Use the existing slot in the higher part of the hook to adjust the selected rail position.
- Fasten the rail tightening the screw with a 10 Nm torque.

Installation hook RH HB A2

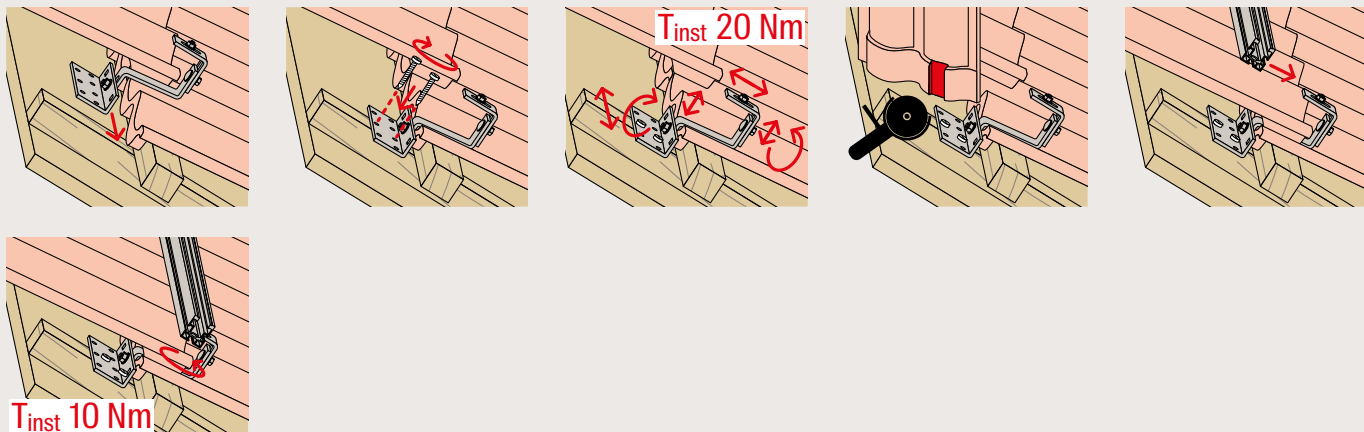

4

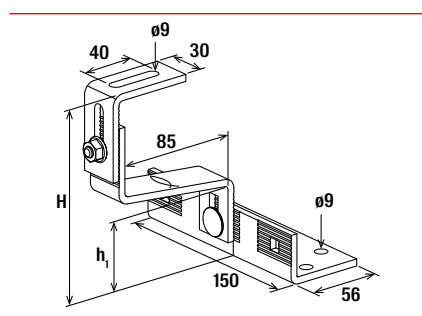

Technical data

Stainless steel hook with large base RH HB A2



RH HB A2

Item	Item no.	Weight [kg]	Thickness S [mm]	Total height H [mm]	Depth [mm]	Under tile height h_1	Width across nut SW [mm]	Installation torque T_{inst} [Nm]	Contents	Sales unit [pcs]
RH 40-54 HB A2	071526	0.83	5.0	110 - 143	85	40 - 54	13	20	10x hooks RH HB A2 10x hex head screws SKS M8 x 20 A2 10x hexagonal nuts MU F M8 A2	10

Hook with large base GT A2

Stainless steel hook with fixed height and large base for the installation of PV panels on pitched tile roofs with ventilation layer.

4



Pitched roof with tiles



Pitched roof with tiles

Applications

- PV panels installation on pitched roofs with tiles with ventilation layer with a total thickness of 43 mm or 68 mm.
- Version for roofs exposed to heavy snow loads available (RH 43 HB W A2).

Advantages

- The large base plate provides a wider fastening surface for an easier connection to the load-bearing structure and allows to offset the fastening point from the exit point of the hook from the tile.
- The GT hooks are available in two heights (130 and 150 mm) for a full compatibility with different types of tiles and ventilation layers.
- The higher adjustment allows to horizontally align the rail.
- The 5 mm thickness versions allow a reduced tile grinding.
- The 8 mm thickness version (RH 43 HB W A2) makes the hook suitable for high snow loads.
- Made of resistant stainless steel.
- The accessories for connecting to the Solar rails are included in the package.

Properties

- X5CrNi 18-10 stainless steel hook in accordance with EN 10088-2:2005.
- Class A2-70 stainless steel bolts in accordance with EN ISO 3506-1/2:2010.

Functioning

- Determine the centre distance of the hooks according to the snow and wind loads in the installation area (use SOLARPANEL-FIX software to design the system) and according to the load-bearing structure and system layout.
- Lift the tile and secure the base of the hook using the appropriate anchor determined according to the type of the load-bearing support.
- Grind the upper tile to fit the hook shape and put it back in position.
- Use the existing slot in the higher part of the hook to adjust the selected rail position.
- Fasten the rail tightening the screw with a 10Nm torque.

Installation stainless steel hook with large base GT A2

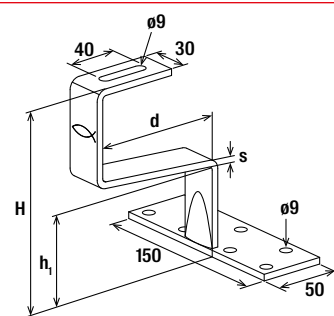
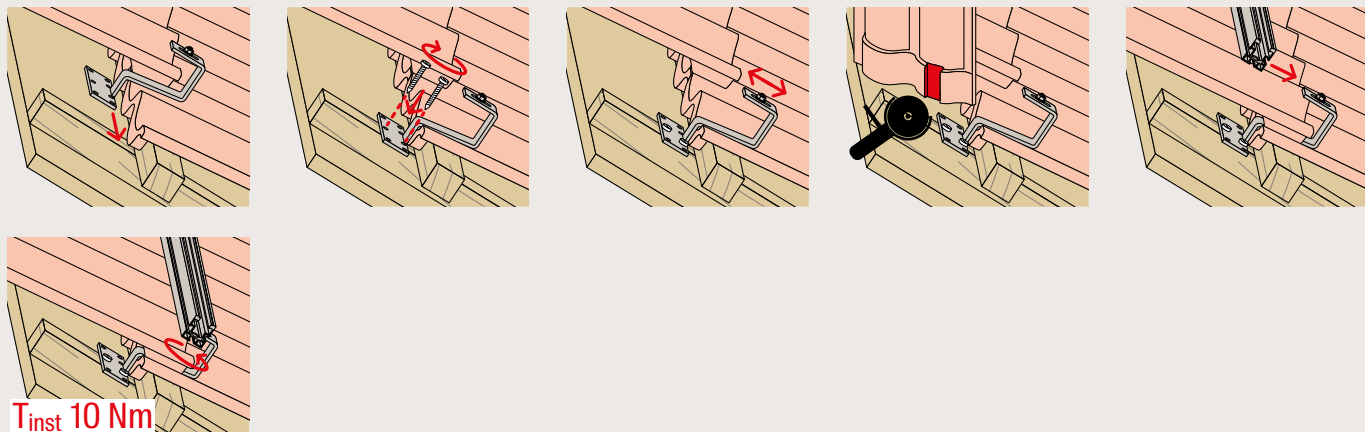

Technical data

Stainless steel hook with large base GT A2



GT A2

Item	Item no.	Weight [kg]	Thickness S [mm]	Total height H [mm]	Depth [mm]	Under tile height h ₁	Width across nut SW [mm]	Installation torque T _{inst} [Nm]	Contents	Sales unit [pcs]
GT 130 A2	071198	0.57	5.0	130	96	43	13	10	10x hooks GT A2 10x hex head screws SKS M8 x 20 A2 10x hexagonal nuts MU F M8 A2	10
RH 43 HB W A2	071422	0.73	8.0	130	90	43	13	10	10x hooks RH 43 HB W A2 10x hex head screws SKS M8 x 20 A2 10x hexagonal nuts MU F M8 A2	10
GT 150 A2	571136	0.6	5.0	150	97	68	13	10	10x hooks GT A2 10x hex head screws SKS M8 x 20 A2 10x hexagonal nuts MU F M8 A2	10

Hook with thin base GTP A2

Stainless steel hook with fixed height for the installation of PV panels on pitched tile roofs without ventilation layer.

4

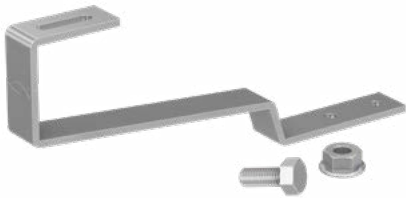

Pitched roof with tiles



Pitched roof with tiles

Applications

PV panels installation on pitched roofs with tiles without ventilation layer with a total thickness of up to 30 mm.

Certificates



Advantages

- The higher adjustment allows to horizontally align the rail.
- The 5 mm thickness allows a reduced tile grinding.
- The GTP A2 hook allows installation with up to 18 cm overlapping tiles.
- Made of resistant stainless steel.
- The accessories for connecting to the Solar rails are included in the package.

Properties

- X5CrNi 18-10 stainless steel hook in accordance with EN 10088-2:2005.
- Class A2-70 stainless steel bolts in accordance with EN ISO 3506-1/2:2010.

Functioning

- Determine the centre distance of the hooks according to the snow and wind loads in the installation area (use SOLARPANEL-FIX software to design the system) and according to the load-bearing structure and system layout.
- Lift the tile and secure the base of the hook using the appropriate anchor determined according to the type of the load-bearing support.
- Grind the upper tile to fit the hook shape and put it back in position.
- Use the existing slot in the higher part of the hook to adjust the selected rail position.
- Fasten the rail tightening the screw with a 10 Nm torque.

Installation stainless steel hook with thin base GTP A2

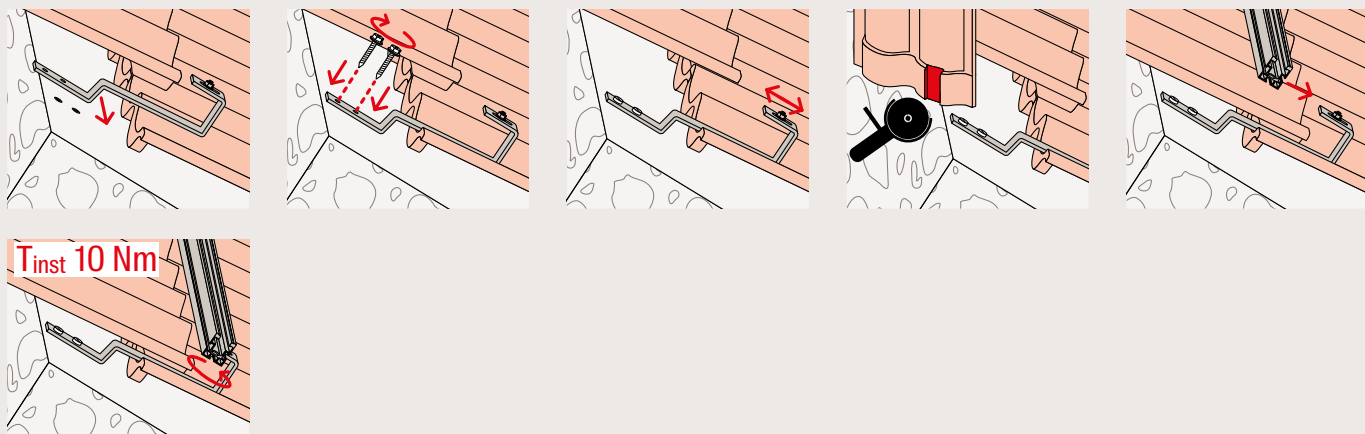

4

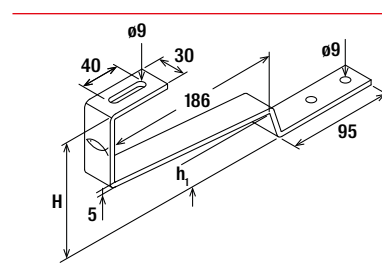

Technical data

Stainless steel hook with thin base GTP A2



GTP A2

Item	Item no.	Weight [kg]	Thickness S [mm]	Total height H [mm]	Depth [mm]	Under tile height h_1	Width across nut SW [mm]	Installation torque T_{inst} [Nm]	Contents	Sales unit [pcs]
GTP A2	071199	0.52	5.0	120	186	30	13	10	10x hooks GTP A2 10x hex head screws SKS M8 x 20 A2 10x hexagonal nuts MU F M8 A2	10

Hook with thin base GTPR A2

Stainless steel adjustable hook for the installation of PV panels on pitched tile roofs without ventilation layer.

4

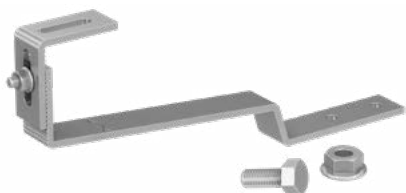

Pitched roof with tiles



Pitched roof with tiles

Applications

PV panels installation on pitched roofs with tiles without ventilation layer with a total thickness of up to 30 mm.

Certificates



Advantages

- The multiple adjustments allow to adapt the hook to different tiles: the vertical adjustment allows to record the distance of the rail from the top of the tile; the higher adjustment allows to horizontally align the rail.
- The 5 mm thickness allows a reduced tile grinding.
- The GTPR A2 hook allows installation with up to 18 cm overlapping tiles.
- Made of resistant stainless steel.
- The hook is pre-assembled and the accessories for connecting to the Solar rails are included in the package.

Properties

- X5CrNi 18-10 stainless steel hook in accordance with EN 10088-2:2005.
- Class A2-70 stainless steel bolts in accordance with EN ISO 3506-1/2:2010.

Functioning

- Determine the centre distance of the hooks according to the snow and wind loads in the installation area (use SOLARPANEL-FIX software to design the system) and according to the load-bearing structure and system layout.
- Lift the tile and secure the base of the hook using the appropriate anchor determined according to the type of the load-bearing support.
- Make the vertical adjustment required by the type of the roof and tighten the screws of the adjustment applying a 20 Nm torque to lock the hook in position.
- Grind the upper tile to fit the hook shape and put it back in position.
- Use the existing slot in the higher part of the hook to adjust the selected rail position.
- Fasten the rail tightening the screw with a 10 Nm torque.

Installation of stainless steel hook with thin base GTPR A2

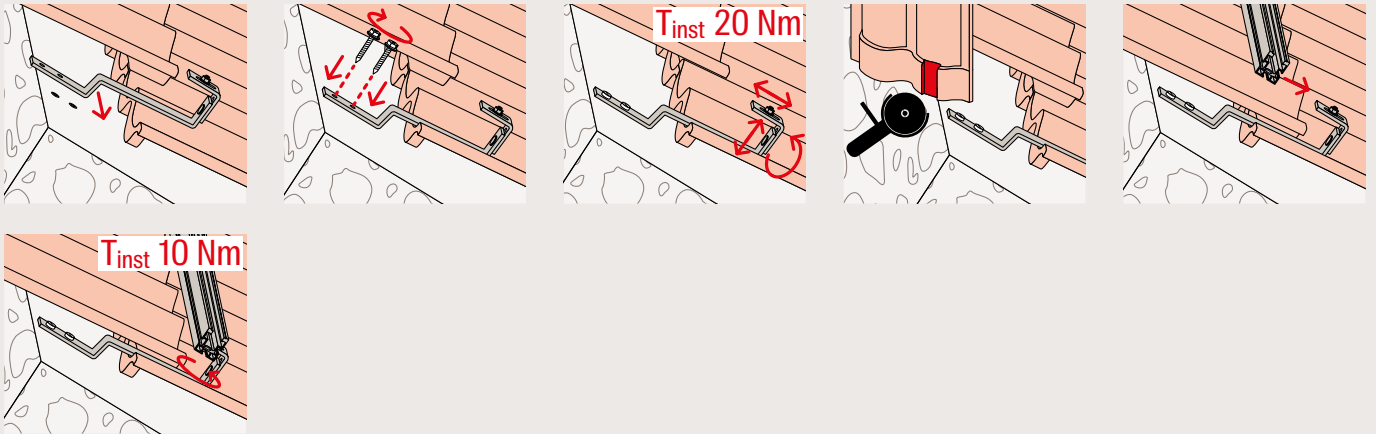

4

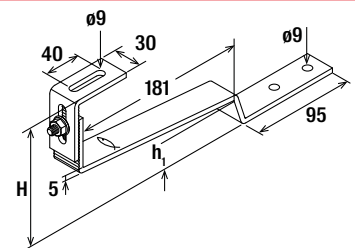

Technical data

Stainless steel hook with thin base GTPR A2



GTPR

Item	Item no.	Weight [kg]	Thickness S [mm]	Total height H [mm]	Depth [mm]	Under tile height h_1	Width across nut SW [mm]	Installation torque T_{inst} [Nm]	Contents	Sales unit [pcs]
GTPR A2	519667	0.57	5.0	110 - 138	181	30	13	20	10x hooks GTPR A2 10x hex head screws SKS M8 x 20 A2 10x hexagonal nuts MU F M8 A2	10

Hook for barrel tiles GC A2

Stainless steel adjustable hook for the installation of PV panels on pitched barrel tile roofs.

4



Pitched roof with barrel tiles



Pitched roof with barrel tiles

Applications

PV panels installation on pitched roofs with barrel tiles.

Certificates



Advantages

- The multiple adjustments allow to adapt the hook to different barrel tiles: the lower vertical adjustment allows to adapt the hook to different thicknesses of tiles; the higher adjustment allows to horizontally align the rail.
- The 5 mm reduced thickness easily fits the barrel tiles.
- Made of resistant stainless steel.
- The hook is pre-assembled and the accessories for connecting to the Solar rails are included in the package.

Properties

- X5CrNi 18-10 stainless steel hook in accordance with EN 10088-2:2005.
- Class A2-70 stainless steel bolts in accordance with EN ISO 3506-1/2:2010.

Functioning

- Determine the centre distance of the hooks according to the snow and wind loads in the installation area (use SOLARPANEL-FIX software to design the system) and according to the load-bearing structure and system layout.
- Lift the barrel tiles and secure the base of the hook using the appropriate anchor determined according to the type of the load-bearing support.
- Make the vertical adjustment required by the type of the roof and tighten the screws of the adjustment applying a 20 Nm torque to lock the hook in position.
- Use the existing slot in the higher part of the hook to adjust the selected rail position.
- Fasten the rail tightening the screw with a 10 Nm torque.

Installation Hook GC

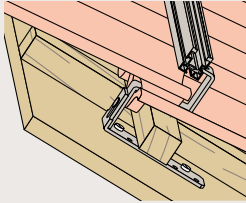
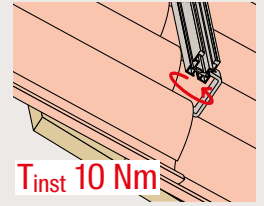
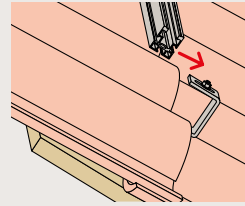
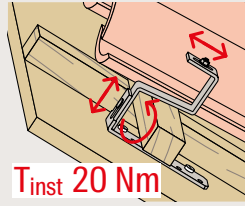
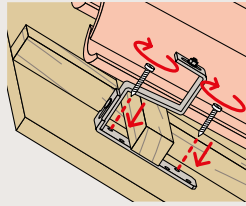
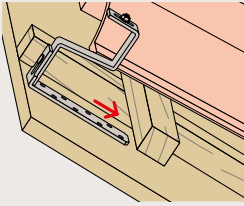

4

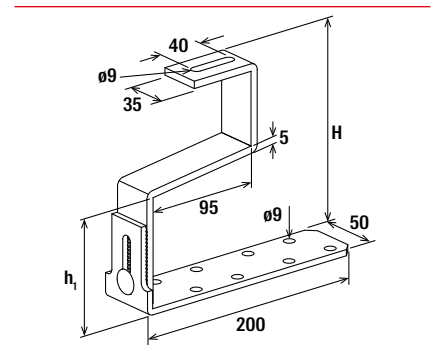

Technical data

Stainless steel hook for barrel tiles GC A2



GC

Item	Item no.	Thickness S [mm]	Total height H [mm]	Depth [mm]	Under tile height h ₁	Width across nut SW [mm]	Installation torque T _{inst} [Nm]	Contents	Sales unit [pcs]
GC A2	571137	5.0	176 - 205	95	91 - 120	13	20	10x hooks GC A2 10x hex head screws SKS M8 x 20 A2 10x hexagonal nuts MU F M8 A2	10

Hook for flat standing seam DLA A2

Stainless steel hook for the installation of PV panels on standing seam sheets. Suitable for flat seaming.

4



Pitched roof with flat standing seam covering

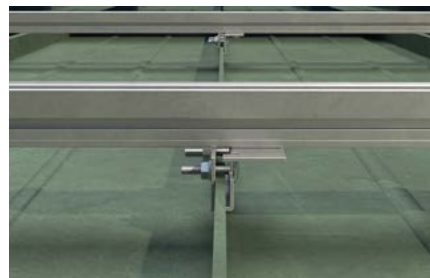

Pitched roof with flat standing seam covering

Applications

PV panels installation on pitched roofs with standing seam with flat seaming.

Advantages

- The accessories for connecting to the Solar rails are included in the package.
- Thanks to its design, the hook perfectly fits the flat standing seam.

Properties

- Hook in stainless steel X5CrNi 18-10 according to EN 10088-2:2005.
- Bolts and nuts in stainless steel A2-70 according to EN ISO 3506-1/2:2010.

Certificates



Functioning

- Determine the centre distance of the hooks according to the snow and wind loads in the installation area (use SOLARPANEL-FIX software to design the system) and according to the conformation of the standing seam.
- Position a layer of CG INT butyl adhesive tape on the sheet at the points where the hooks will be installed.
- Position the hook on the seam.
- Fasten the hook by tightening the flange nut on the pan head screw.
- Use the existing slot in the higher part of the hook to fasten the selected rail tightening the screw with a 10 Nm torque.

Installation stainless steel hook for flat standing seam DLA A2

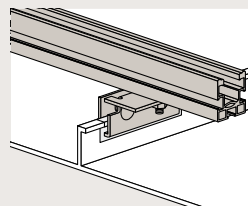
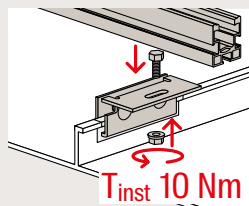
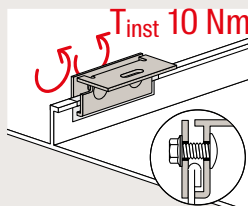
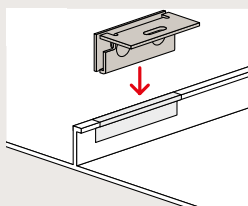
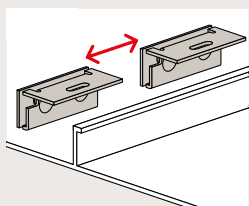

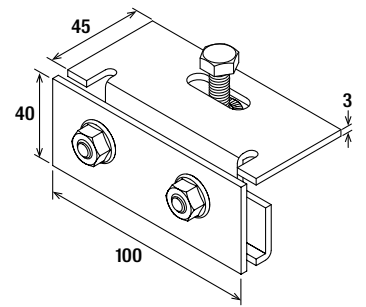

Technical data

Stainless steel hook for flat standing seam DLA A2



DLA A2

Item	Item no.	Weight [kg]	Thickness S [mm]	Width across nut SW [mm]	Installation torque T_{inst} [Nm]	Contents	Sales unit [pcs]
DLA A2	071556	0.33	3.0	13	10	10 hooks DLA A2 10 hex head screws SKS M8 x 20 A2 30 hexagonal nuts MU F M8 A2 20 pan head screws M8 x 20 A2	10

Hook for rounded standing seam DLAK A2

Stainless steel hook for the installation of PV panels on standing seam sheets. Suitable for rounded seaming (e.g. Kalzip).

4

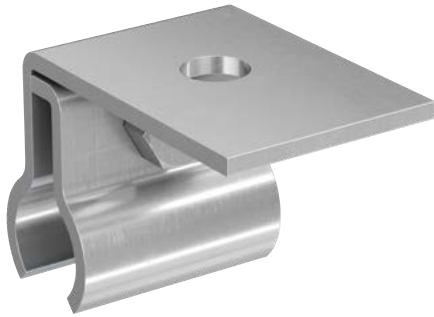

Pitched roof with rounded standing seam covering



Pitched roof with rounded standing seam covering

Applications

PV panels installation on pitched roofs with rounded standing seam (e.g. Kalzip).

Advantages

- The hook is pre-assembled.
- Thanks to its design, the hook perfectly fits the rounded standing seam.

Properties

- Hook in stainless steel X5CrNi 18-10 according to EN 10088-2:2005.
- Bolts and nuts in stainless steel A2-70 according to EN ISO 3506-1/2:2010.

Certificates



Functioning

- Determine the centre distance of the hooks according to the snow and wind loads in the installation area (use SOLARPANEL-FIX software to design the system) and according to the conformation of the standing seam.
- Position a layer of CG INT butyl adhesive tape on the sheet at the points where the hooks will be installed.
- Position the hook clamping the seam.
- Fasten the hook by tightening the flange nut on the screw.
- Use the existing hole in the higher part of the hook to fasten the selected rail tightening the screw with a 10 Nm torque.

Installation hook DLAK A2

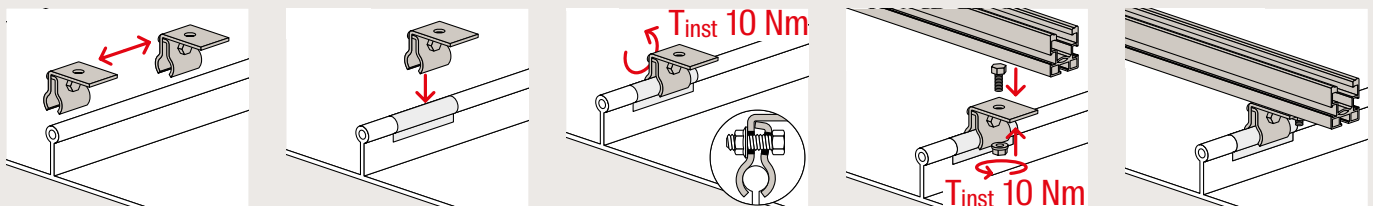

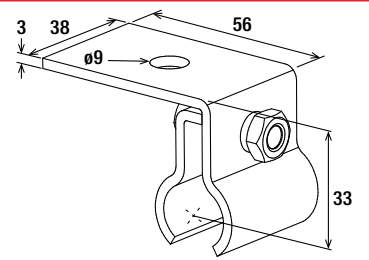

Technical data

Stainless steel hook for rounded standing seam DLAK A2

4

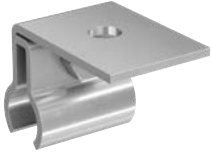

DLAK A2

Item	Item no.	Weight [kg]	Thickness S [mm]	Width across nut SW [mm]	Installation torque T_{inst} [Nm]	Sales unit [pcs]
DLAK A2	536782	0.25	3.0	13	10	50

Bracket for horizontal PV panels LAB AL

Angle connection bracket for the installation of landscape oriented PV panels on pitched roofs with tiles.

4



Pitched roof with tiles and landscape oriented PV panels

Applications

Landscape oriented PV panels installation on pitched roof with tiles covering, in combination with RH VB AL and RH V AL hooks.

Advantages

- Connection screw and nut are included in the package.
- The bracket design perfectly fits the hook shape and helps keeping the screw in position while fastening the nut.

Properties

- Bracket in aluminum alloy EN AW 6060 T66.
- Class A2-70 stainless steel bolts in accordance with EN ISO 3506-1/2:2010.

Functioning

- Remove the RHS 8x20 A2 hammer head screw, the hexagonal MU F nut and the anti-slip plate pre-mounted on the hook.
- Position the LAB bracket to the flat upper part of the hook and adjust the height according to the configuration needs.
- Fit the screw head between the LAB ribs, place the anti-slip plate and the MU F nut on the knurled side of the hook and tighten the nut.
- Connect the Solar rail to the hook through the RHS 8x20 A2 hammer head screw.
- Fasten the MU F nut applying a 10 Nm torque.

Installation bracket LAB AL with RH hook

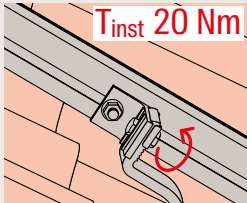
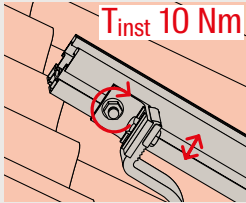
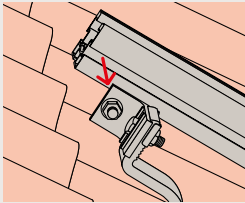
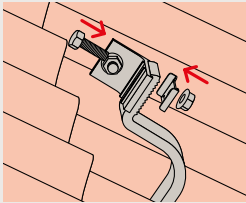
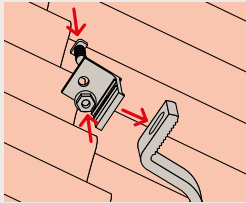
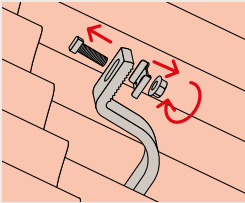

4

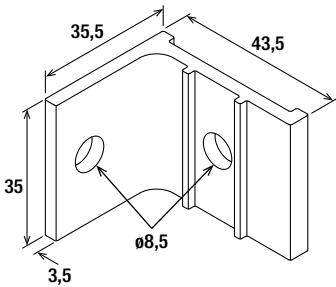

LAB

Technical data

Bracket for landscape oriented PV panels LAB AL







LAB AL

Item	Item no.	Weight [g]	Width across nut SW [mm]	Installation torque T _{inst} [Nm]	Contents	Sales unit [pcs]
LAB AL	571788	26	13	10	1x flanged nut MU F M8 A2 1x hex head screw SKS M8 x 30 A2	20



5

Stud screws

Stud screw STSI A2	86	
Stud screw STSR A2	88	
Connection bracket MW A2	92	
Flat connection bracket SSP A2	94	
Flat connection bracket SSP Speed A2	96	

Stud screw STSI A2

Double-threaded screw for fastening photovoltaic systems on roofs with a steel load-bearing structure covered by corrugated panels, faux panels or tiles.



5



Pitched roof with corrugated sheets covering



Roof with trapezoidal metal sheet covering

Applications

Installation of PV panels on roofs with a steel load-bearing structure covered by corrugated panels, faux panels or tiles.

Certificates



Advantages

- The STSI double-threaded screw is supplied pre-assembled with EPDM gasket and pair of nuts for connection to the MW or SSP brackets.
- The roofing must not be removed during installation.
- Thanks to the EPDM gasket, waterproofness of the roof is maintained.

Properties

Stud and nuts in stainless steel A2-70 according to EN ISO 3506-1/2:2009.

Functioning

- Determine the centre distance of the STSI double-threaded screws according to the snow and wind loads of the system installation area and inclination of the roof.
- Identify the position of the STSI double-threaded screws depending on the load-bearing structure and the layout of the installation.
- Drill the support according to the diameter of the screw.
- Tighten the STSI double-threaded screw until the gasket is fully in contact with the roof covering.
- Carefully seal the exit point of the screw from the roof with bituminous sealant in order to improve waterproofness.
- Connect the Solar rail to the upper part of the screw by inserting SSP or MW connection plates, adjusting their height using the MU nuts.

Building materials

Steel beams.

Installation stud screw STSI

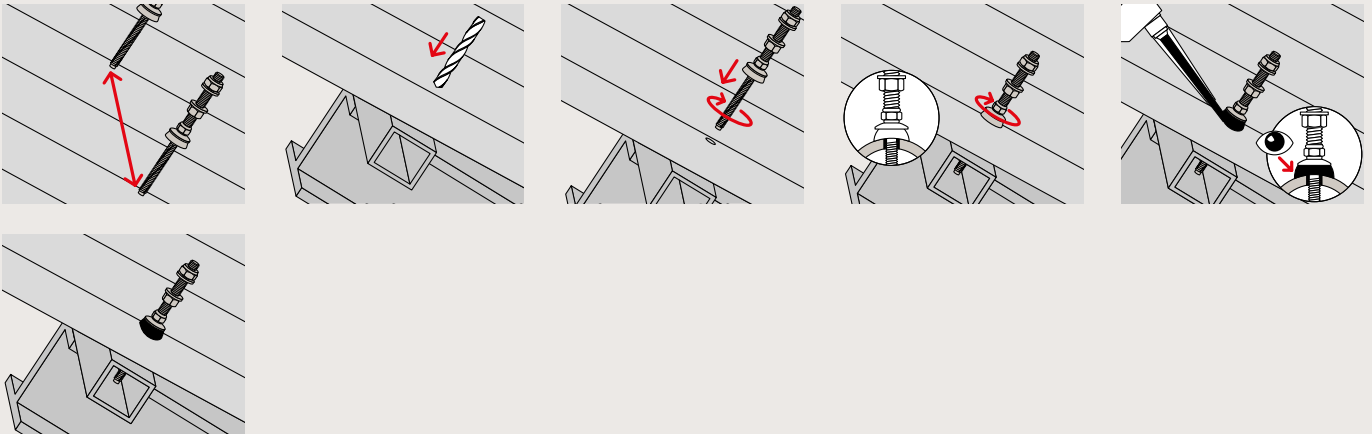

5

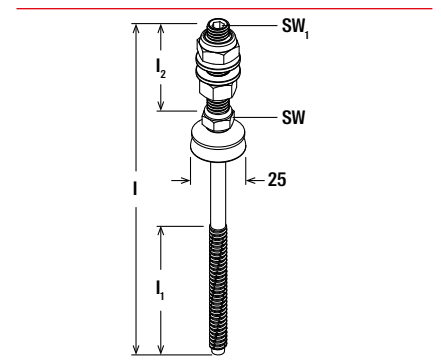

Technical data

Stud screw STSI A2



STSI

Item	Item no.	Weight [kg]	Length l [mm]	Steel thread length l ₁ [mm]	Metric thread length l ₂ [mm]	Thread	Diameter d [mm]	Width across nut SW [mm]	Width across nut SW ₁ [mm]	Sales unit [pcs]
STSI M10 x 181 mm A2	533376	0.18	181	70	50	M10	8.0	13	5	10

Technical data

Accessories



MU F

Item	Item no.	Thread	Width across nut SW [mm]	Sales unit [pcs]
MU F M10 A2	071952	M10	17	100

Stud screw STSR A2

Double-threaded screw for fastening photovoltaic systems on roofs with wooden, concrete or hollow bricks and concrete load-bearing structure, covered by corrugated panels, faux panels or tiles.



5



Pitched roof with corrugated sheets covering



Pitched roof with tiles covering

Applications

Installation of PV panels on roofs with wooden, concrete or hollow bricks and concrete load-bearing structure, covered by corrugated panels, faux panels or tiles.

Certificates



Advantages

- The STSR double-threaded screw is supplied pre-assembled with EPDM gasket, tightening nut and pair of nuts for connection to the MW or SSP brackets.
- The roofing must not be removed during installation.
- Thanks to the EPDM gasket, waterproofness of the roof is maintained.

Properties

Stud and nuts in stainless steel A2-70 according to EN ISO 3506-1/2:2009.

Functioning

- Determine the centre distance of the STSR double-threaded screws according to the snow and wind loads of the system installation area and inclination of the roof.
- Drill the support according to the diameter of the screw and the type of support.
- In case of concrete, fasten the STSR double-threaded screw into the structure using a chemical injection mortar.
- In case of hollow bricks covered by concrete, fasten the STSR double-threaded screw into the structure using a chemical injection mortar and FIS HK injection anchor sleeve.
- In case of wooden beams, fasten the STSR double-threaded screw into the structure after pre-drilling it.
- Tighten the STSR double-threaded screw until the gasket is fully in contact with the roof covering.
- Carefully seal the exit point of the screw from the roof with bituminous sealant in order to improve waterproofness.

Building materials

- Concrete beams and slabs.
- Hollow brick and concrete slabs.
- Wooden beams.

Installation stud screw STSR in concrete substructure

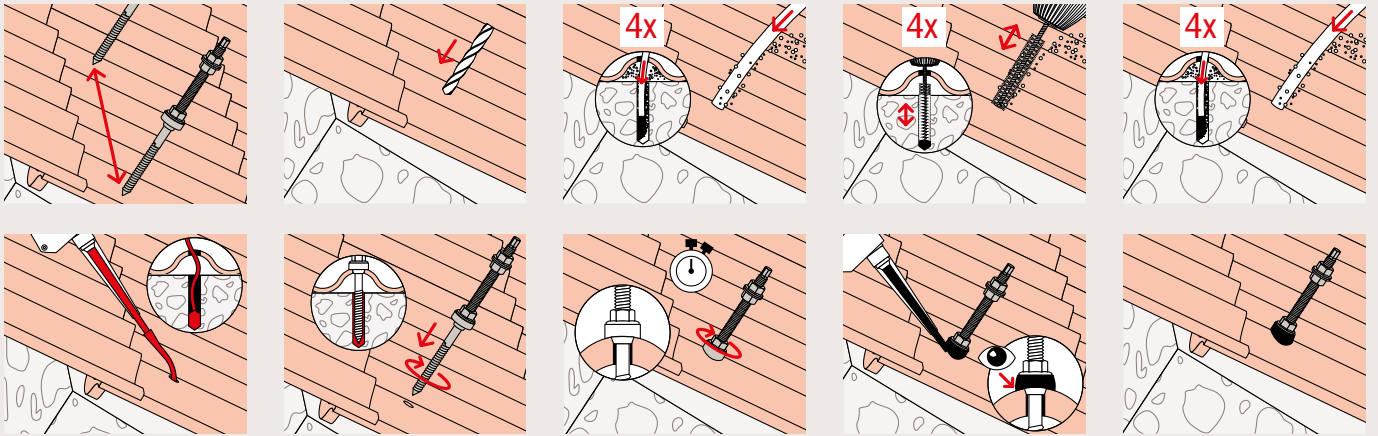

Installation stud screw STSR in hollow brick substructure

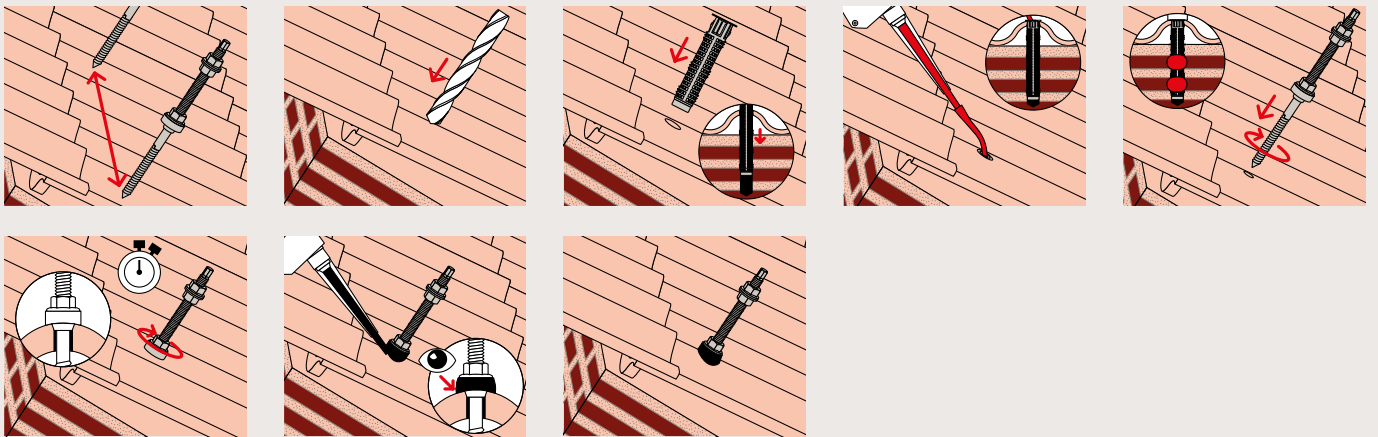

Installation stud screw STSR in wood substructure

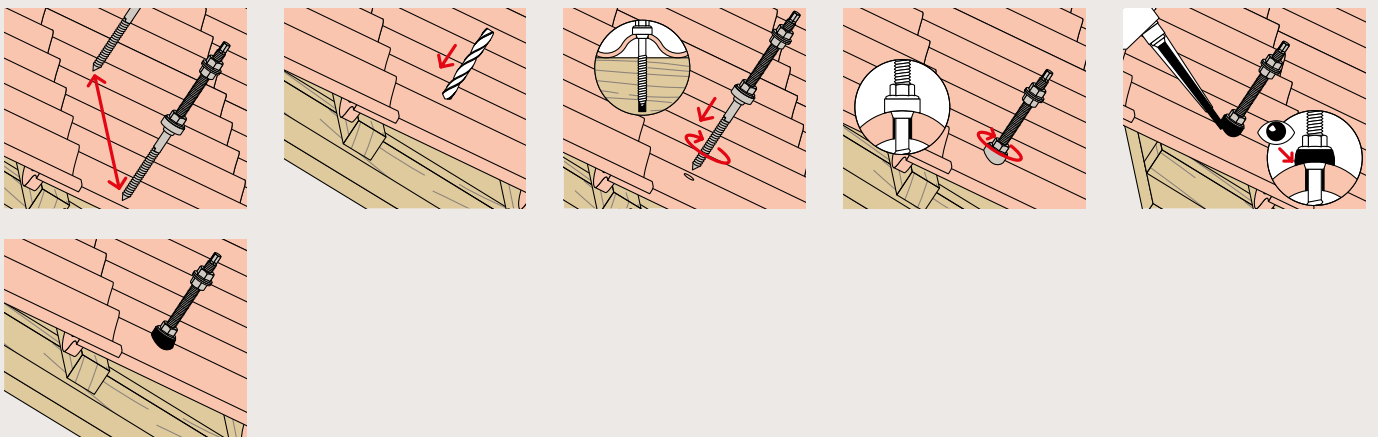

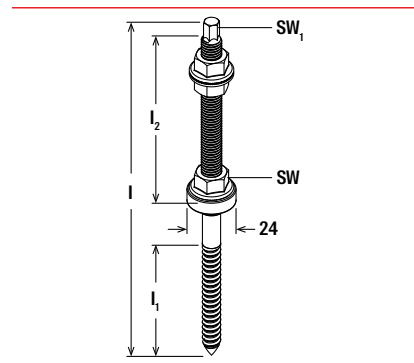

5 Technical data

Stud screw STSR A2



Item	Item no.	Weight [kg]	Length l [mm]	Wood thread length l ₁ [mm]	Metric thread length l ₂ [mm]	Thread M	Diameter d [mm]	Width across nut SW [mm]	Width across nut SW ₁ [mm]	Sales unit [pcs]
STSR M10 x 200 mm A2	071202	0.13	200	66	90	M10	9.0	15	7	25
STSR M10 x 250 mm A2	071203	0.16	250	66	90	M10	9.0	15	7	25
STSR M10 x 300 mm A2	570692	0.22	300	100	150	M10	11.0	15	7	25
STSR M12 x 300 mm A2	071204	0.28	300	100	150	M12	11.0	18	9	25
STSR M12 x 350 mm A2	570113	0.32	350	100	200	M12	11.0	18	9	25

Technical data

Washer G EPDM



Item	Item no.	Diameter d [mm]	Thickness S [mm]	Sales unit [pcs]
G EPDM M10	071748	24	7.5	50

Technical data

Flanged hexagonal nut MU F



Item	Item no.	Thread M	Width across nut SW [mm]	Sales unit [pcs]
MU F M10 A2	071952	M10	17	100
MU F M12 A2	071749	M12	19	100

Technical data

injection mortar FIS V Plus



FIS V Plus 410 C

Item	Item no.	Approval			Contents	Sales unit
		ETA	DIBt	ICC		[pcs]
FIS V Plus 410 C	558780	●	●	●	1 x cartridge 410 ml, 2 x static mixer FIS MR Plus	1

Technical data

Injection anchor sleeves



FIS H K

FIS HK

Item	Item no.	Sales unit
		[pcs]
FIS H 16 x 130 K	041905	50
FIS H 20 x 130 K	046703	20
FIS H 20 x 200 K	046704	20
FIS H 18 x 130/200 K	045707	10

5

Connection bracket MW A2

Angle bracket for the connection between Solar rails and double-threaded screws.

5



Pitched roof with tiles covering



Roof with trapezoidal metal sheet covering

Applications

PV panels installation on roofs in combination with STSR and STSI double-threaded screws. Compatible with SolarLight, SolarFish and SolarMid rails.

Certificates



Advantages

- Fast connection to STSR and STSI double-threaded screws thanks to the bottom hole.
- Adjustable rail height thanks to the slotted side hole.

Properties

X5CrNi 18-10 stainless steel hook in accordance with EN 10088-2:2005.

Functioning

- Insert the MW A2 angle bracket between the two nuts of the STSR/STSI double-threaded screw, adjust the position of the bracket and tighten the nuts.
- Connect the Solar rail to the MW A2 bracket through the slotted hole using SKS M8 x 20 A2 or RHS M8 x 20 A2 screws and MU F M8 flanged hex nut.

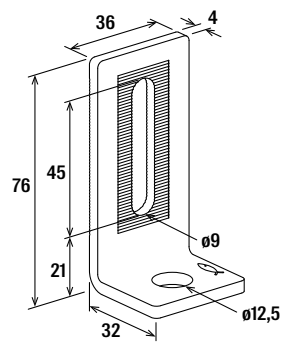

MW SA

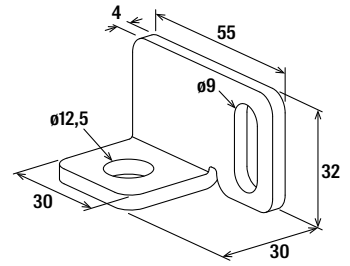

MW SU

Technical data

Angle bracket MW



MW SA



MW SU

Item	Item no.	Weight [g]	Thickness S [mm]	Hole-Ø D [mm]	Installation torque T _{inst} [Nm]	Sales unit [pcs]
MW SU A2	522676	65	4.0	12.5	10	10
MW SA A2	518952	94	4.0	12.5	10	10

Accessories

Accessories

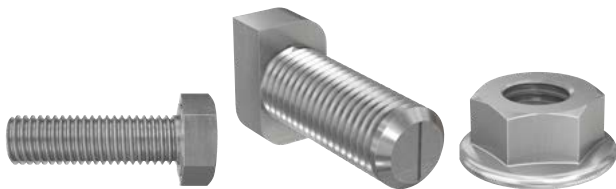

SKS

RHS

MU F

Item	Item no.	Thread M	Length L [mm]	Width across nut SW [mm]	Sales unit [pcs]
SKS M8 x 20 mm A2	505614	M8	20	13	100
RHS 8.0 x 20 mm A2	071207	M8	20	13	50
MU F M8 A2	571210	M8	-	13	100

Flat connection bracket SSP A2

Flat bracket for the connection between Solar rails and double-threaded screws.



5



Pitched roof with corrugated sheets covering



Pitched roof with corrugated sheets covering

Applications

PV panels installation on roofs in combination with STSR and STSI double-threaded screws. Compatible with SolarLight, SolarFish and SolarMid rails.

Certificates



Advantages

- Easy installation thanks to the slotted hole that allows to adjust the positioning of the rail.
- Two versions available to fit all the STSR and STSI double-threaded screws variants.

Properties

Plates in stainless steel X5CrNi 18-10 (A2) according to EN 10088-2:2014.

Functioning

- Insert the bracket between the stud screw STSR/STSI 2 nuts through the circular hole.
- Use the stud screw STSR/STSI lower nut for adjusting the bracket position.
- Tighten the 2 nuts.
- Connect the Solar rail to the bracket and adjust its position through the slotted hole using SKS M8 x 20 A2 or RHS M8 x 20 A2 screws and MU F M8 flanged hex nut.

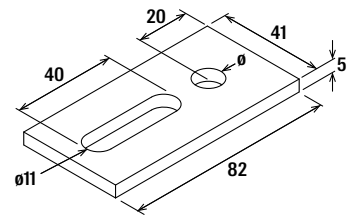

SSP 10

Technical data

Flat connection bracket SSP



SSP

Item	Item no.	Weight [g]	Thickness S [mm]	Hole-Ø D [mm]	Installation torque T _{inst} [Nm]	Sales unit [pcs]
SSP 10 A2	071205	100	5.0	11	10	25
SSP 12 A2	071206	100	5.0	13	10	25

Accessories

Accessories

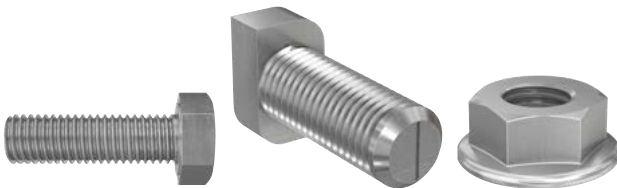

SKS

RHS

MU F

Item	Item no.	Thread M	Length L [mm]	Width across nut SW [mm]	Sales unit [pcs]
SKS M8 x 20 mm A2	505614	M8	20	13	100
RHS 8.0 x 20 mm A2	071207	M8	20	13	50
MU F M8 A2	571210	M8	-	13	100

Flat connection bracket SSP Speed A2

Flat bracket with pre-assembled quick joint for the connection between Solar rails and double-threaded screws.

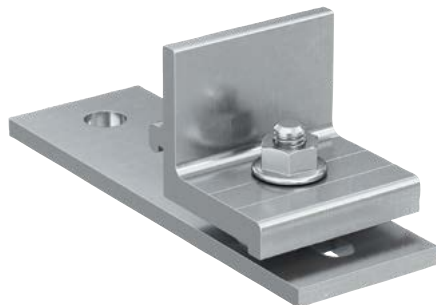

5



Pitched roof with corrugated sheets covering



Roof with trapezoidal metal sheet covering

Applications

PV panels installation on roofs in combination with STSR and STSI double-threaded screws. Compatible with SolarFish and SolarMid rails.

Certificates



Advantages

- Easy installation thanks to the pre-assembled quick connection joint by tightening a single screw.
- Adjustable rail positioning thanks to the slotted hole.
- Two versions available to fit all the STSR and STSI double-threaded screws variants.

Properties

- Plates in stainless steel X5CrNi 18-10 (A2) according to EN 10088-2:2014.
- Angle bracket in aluminium alloy AW 6063 T6 according to EN 755-2:2013.
- Bolts and nuts in stainless steel A2-70 according to EN ISO 3506-1/2:2009.

Functioning

- Insert the bracket between the stud screw STSR/STSI 2 nuts through the circular hole.
- Use the stud screw STSR/STSI lower nut for adjusting the bracket position.
- Tighten the 2 nuts.
- Insert the angle bracket on the side of the selected rail and adjust the rail position.
- Fasten the nut applying a 10 Nm torque.

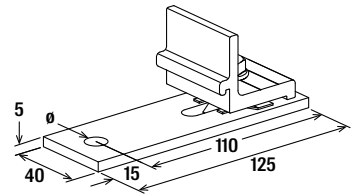

SSP Speed

Technical data

Flat connection bracket SSP Speed



SSP Speed

Item	Item no.	Weight [g]	Thickness S [mm]	Hole-Ø D [mm]	Width across nut SW [mm]	Installation torque T_{inst} [Nm]	Sales unit [pcs]
SSP 10 Speed A2	522672	251	5.0	11	13	10	10
SSP 12 Speed A2	522673	251	5.0	13	13	10	10

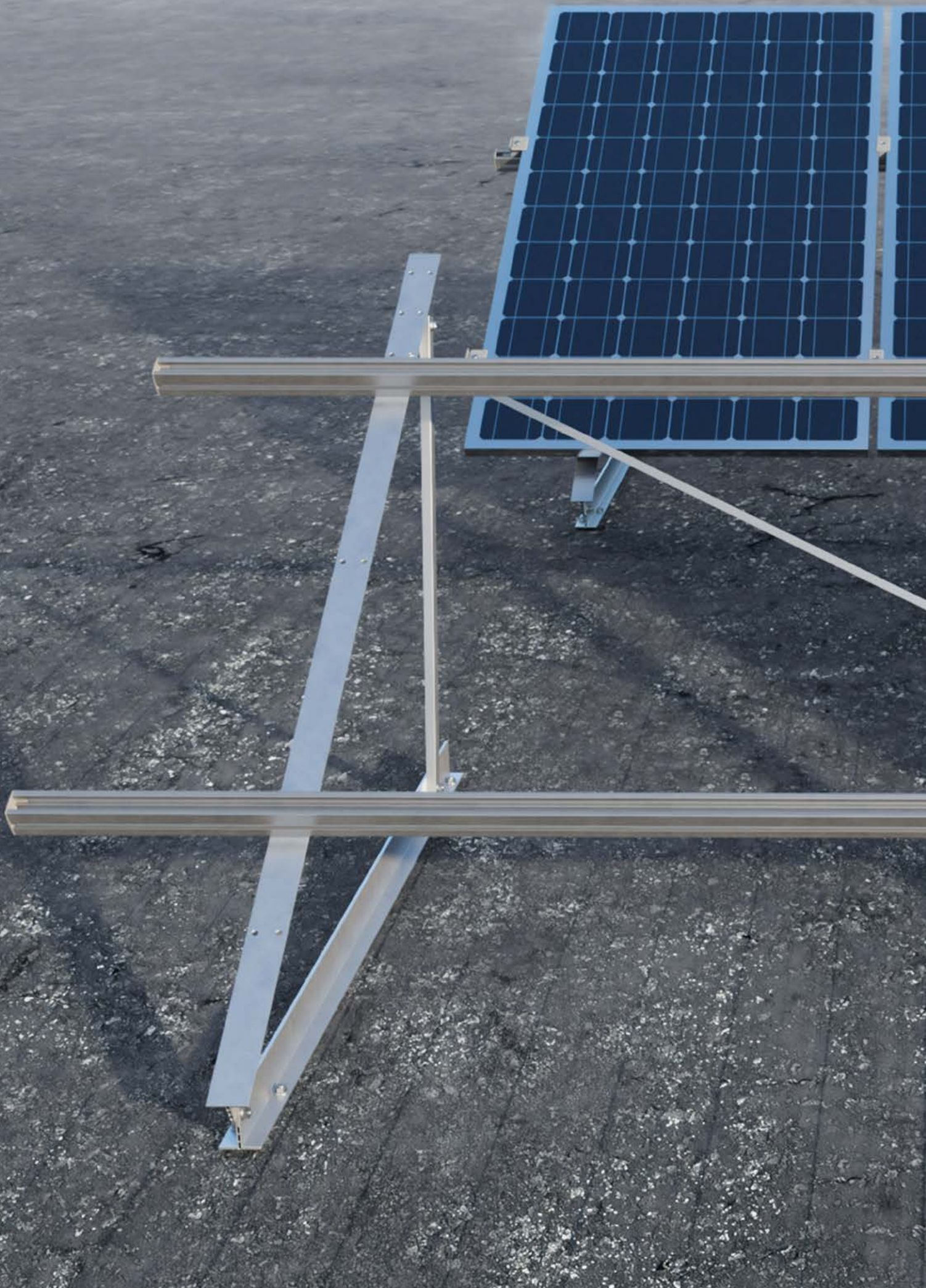

6

Triangles

Pre-assembled triangular frame STFS 100



Pre-assembled triangular frame STFN 102



Pre-assembled triangular frame STFS

Pre-assembled triangular frame for the installation of PV panels in a lowered position on flat roofs. Suitable for landscape layout installation.

6



Flat roof



Flat roof

Applications

Landscape oriented PV panels installation on flat roofs. PV panels inclination of 10° or 13°.

Certificates



Advantages

- The STFS triangular frame is pre-assembled and all the accessories for the connection to the Solar rails are included in the package.
- Adjustable angle 10°-13°.
- The lowered design allows an only 30 cm high installation (suitable for a reduced visual impact).

Properties

- Triangular structure in AW 6063 T66 or AW 6060 T66 aluminium in accordance with EN 755-2:2013.
- A2-70 stainless steel bolts in accordance with EN ISO 3506-1/2:2009.

Functioning

- Determine the centre distance of the triangular frames according to the snow and wind loads in the installation area (use the SOLARPANEL-FIX software).
- Select the desired angle and fasten the diagonal strut in the corresponding position.
- Fasten the base with the appropriate anchor depending on the building material of the roof.
- Connect the Solar rail to the triangular frame using the screws supplied in the package.

Installation flat roof triangle STFS

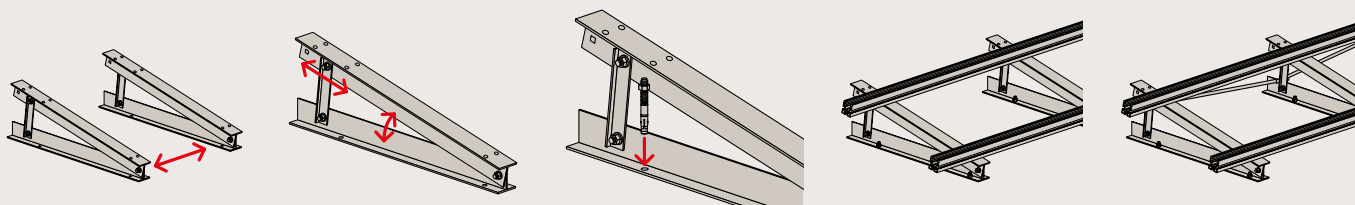

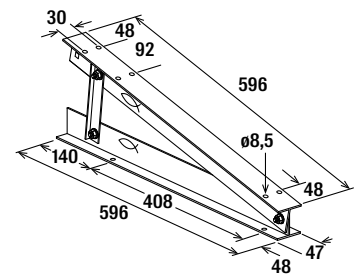

Technical data

Pre-assembled triangular frame STFS



STFS

Item	Item no.	Weight [kg]	Rail cross section [cm ²]	Moment of inertia I_y [cm ⁴]	Section modulus W_y [cm ³]	Hole-Ø D [mm]	Width across nut SW [mm]	Installation torque T_{inst} [Nm]	Contents	Sales unit [pcs]
STFS 10° - 13°	512625	1	3.04	7.23	1.97	8.5	13	10	5x STFS triangles 20x RHS M8 x 20 A2 hammer head screws 20x MU F M8 A2 flanged nuts	5

Accessories

Accessories

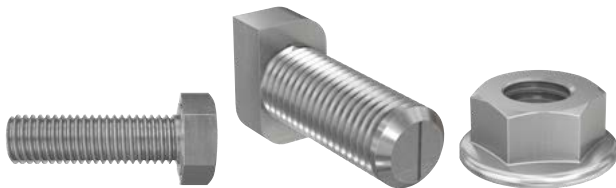

SKS

RHS

MU F

Item	Item no.	Thread M	Length L [mm]	Width across nut SW [mm]	Sales unit [pcs]
SKS M8 x 20 mm A2	505614	M8	20	13	100
RHS 8.0 x 20 mm A2	071207	M8	20	13	50
MU F M8 A2	571210	M8	-	13	100

Pre-assembled triangular frame STFN

Pre-assembled triangular frame for the installation of PV panels on flat roofs. Suitable for portrait or landscape layout installation.

6



Flat roof



Flat roof

Applications

Portrait or landscape oriented PV panels installation on flat roofs. PV panels inclination of 10°-15° or 25°-30°-35°.

Advantages

- The STFN triangular frame is pre-assembled and all the accessories for the connection to the Solar rails are included in the package.
- Adjustable angle 10°-15° or 25°-30°-35°.
- Suitable both for portrait or landscape PV panels orientation.
- Two versions available: traditional and for long PV panels up to 2150 mm.

Properties

- Triangular structure in AW 6063 T66, AW 6060 T5, AW 6060 T6 or AW 6060 T66 aluminium in accordance with EN 755-2:2013.
- A2-70 stainless steel bolts in accordance with EN ISO 3506-1/2:2009.

Functioning

- Determine the centre distance of the triangular frames according to the snow and wind loads in the installation area (use the SOLARPANEL-FIX software).
- Select the desired angle and fasten the diagonal strut in the corresponding position.
- Fasten the base with the appropriate anchor depending on the building material of the roof.
- Connect the Solar rail to the triangular frame using the screws supplied in the package.

Installation flat roof triangle STFN

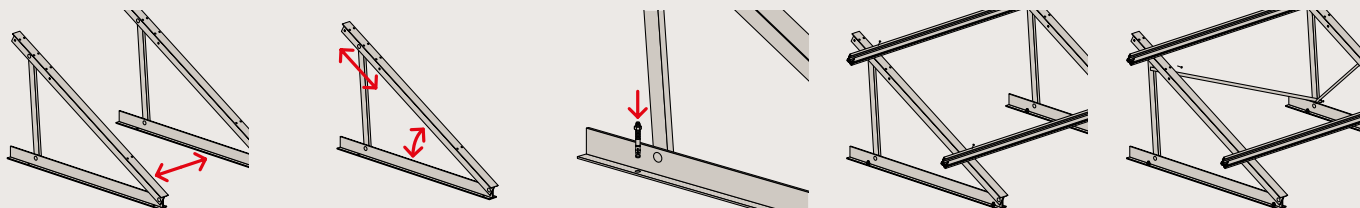

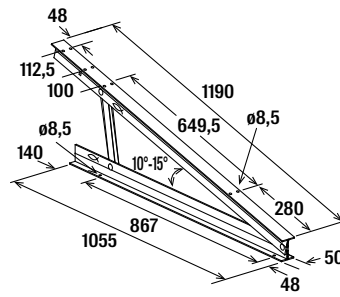

STFN 10°-15°

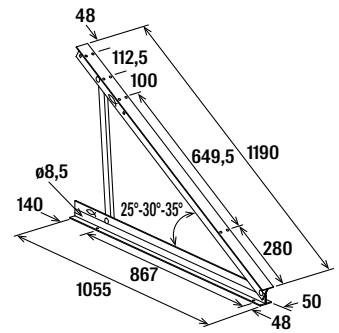

STFN 25°-30°-35°

Technical data

Pre-assembled triangular frame STFN for portrait and landscape installation of PV panels

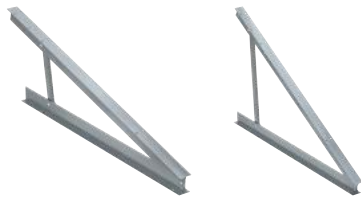

STFN 10° - 15°

STFN 25° - 30° - 35°

Item	Item no.	Weight [kg]	Rail cross section [cm ²]	Hole-Ø D [mm]	Width across nut SW [mm]	Installation torque T _{inst} [Nm]	Contents	Sales unit [pcs]
STFN 10°-15°	524335	2.05	3.78	9	13	10	5x STFN triangles 20x RHS M8 x 20 A2 hammer head screws 20x MU F M8 A2 flanged nuts	5
STFN 25°-30°-35°	511874	2.53	3.78	9	13	10	5x STFN triangles 20x RHS M8 x 20 A2 hammer head screws 20x MU F M8 A2 flanged nuts	5

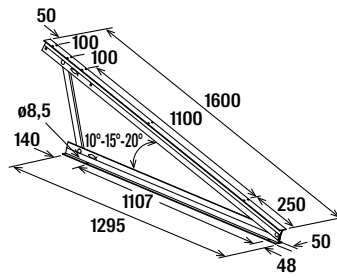

STFN 200 10°-15°-20°

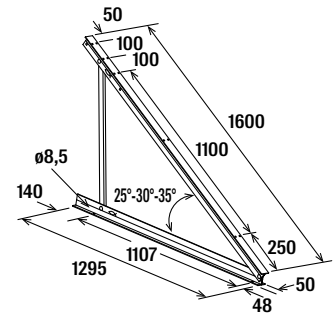

STFN 200 25°-30°-35°

Technical data

6

Pre-assembled triangular frame STFN 200 for portrait installation of PV panels up to 2150 mm length



STFN 200 10° - 15° - 20°

STFN 200 25° - 30° - 35°

Item	Item no.	Weight	Rail cross section	Hole-Ø	Width across nut	Installation torque	Contents	Sales unit
		[kg]	[cm ²]	D [mm]	SW [mm]	T _{inst} [Nm]		[pcs]
STFN 200 10°-15°-20°	558500	3.4	3.78	10.5	13	10	5x STFN 200 triangles 20x RHS M8 x 20 A2 hammer head screws 20x MU F M8 A2 flanged nuts	5
STFN 200 25°-30°-35°	558501	4	3.78	10.5	13	10	5x STFN 200 triangles 20x RHS M8 x 20 A2 hammer head screws 20x MU F M8 A2 flanged nuts	5

Accessories

Accessories

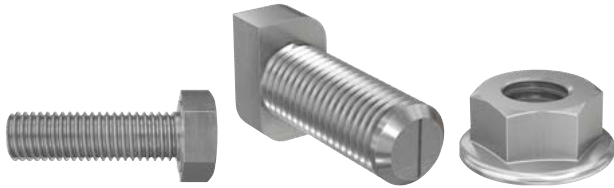

SKS

RHS

MU F

Item	Item no.	Thread M	Length L [mm]	Width across nut SW [mm]	Sales unit [pcs]
SKS M8 x 20 mm A2	505614	M8	20	13	100
RHS 8.0 x 20 mm A2	071207	M8	20	13	50
MU F M8 A2	571210	M8	–	13	100



7 Service

Inhalt

7

Software FIXperience	108
Service	109



FiXperience. Safe and reliable.

The fischer design Software FiXperience gives you safe and reliable support in dimensioning your projects whether you are a planner, structural engineer or craftsman. FiXperience is set up modularly

and useable for a variety of applications. The program includes an engineering software with special application modules:



C-FIX

The anchor design program for steel and bonded anchor in concrete, as well as injection systems for masonry. Now with the new FEM design tool for the realistic design of anchorages.



MORTAR-FIX

To determine the injection resin volume for bonded anchors in concrete and masonry.



WOOD-FIX

For the calculation of on-rafter insulation systems and joints in structural timber engineering.



RAIL-FIX

For the design of fixings for railings on reinforced concrete slabs and staircases.



INSTALL-FIX

For the design and dimensioning of MEP installation systems.



FACADE-FIX

For the design of façade fixings with timber sub-structure.

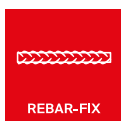

REBAR-FIX

For the design of post-installed rebars in reinforced concrete.



CHANNEL-FIX

For the design of cast-in channels and inserts.



SOLARPANEL-FIX

For the design and dimensioning of mounting systems for photovoltaic panels.

Register on the [myfischer portal](#) to use **FiXperience online** or **download FiXperience** for free.

fischer design software

SOLARPANEL-FIX.

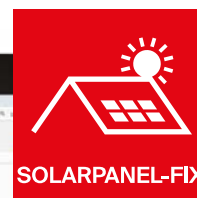
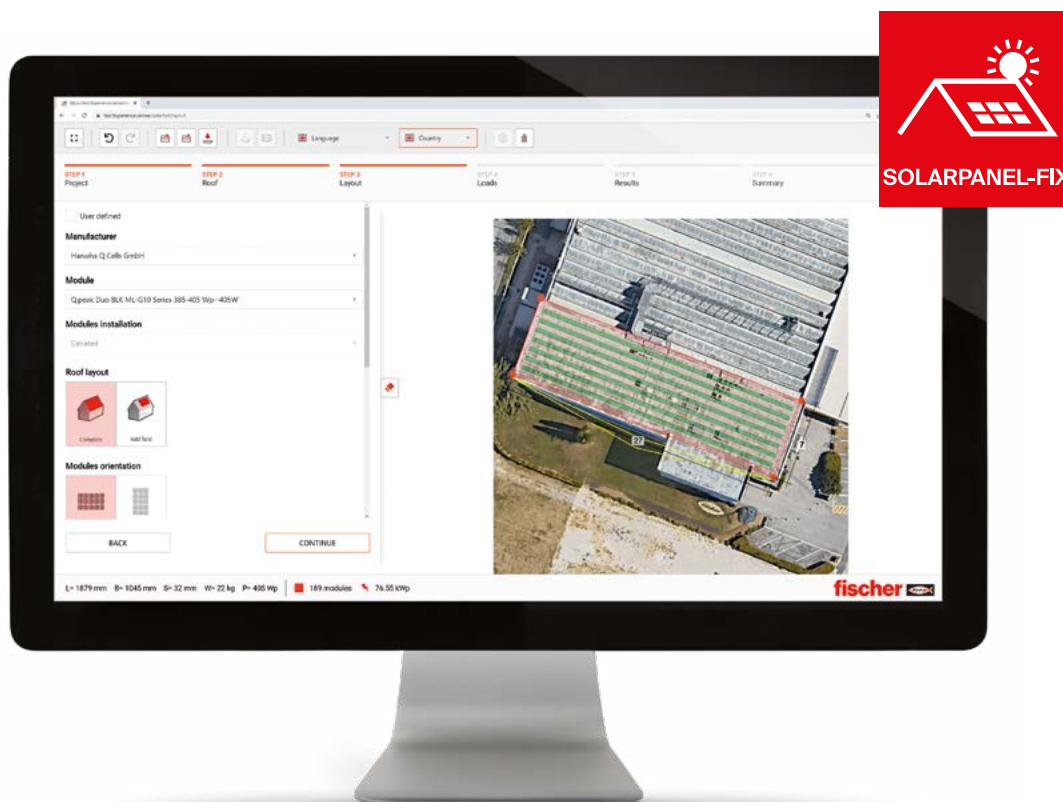

7

Discover the new SOLARPANEL-FIX calculation software.

SOLARPANEL-FIX is an Online module of the FiXperience Suite for the design of mounting systems for photovoltaic panels. It supports professionals in the design of the photovoltaic substructure through a clear and logical flow.

The software allows to **automatically calculate the actions of snow and wind loads through the geolocation of the construction site.** In addition, it allows to download the bill of materials to create the substructure, the installation plan and a technical report.



Find out more information at
<https://software.solar-fix.com>

Catalogue fixing systems.

Products for use in fixing technology.

The fixing catalogue offers many facts and helps with quick and safe product selection, e.g.:

- Produktbeschreibungen mit Vorteile/Nutzen im Überblick
- Tips for installation
- Application aids
- Detailed technical data and drawings
- Basics of fastening technology
- All you need to know about professional fixing



7

Order now: info@fischer.com

Main catalogue EWI.

All about the fischer range for façades with external thermal insulation composite systems (ETICS) for new build and renovation.

We offer a wide range of fixing solutions for the installation of insulation boards, such as:

- Products for different building materials, materials, thicknesses and fire protection and system requirements.
- System providers and installers of ETICS can find the optimal building the optimum solution in terms of building physics, easy to apply and safe solution within the framework of the European Technical Assessment (ETA).



Order now: verkaufsinendienst@fischer.de

Catalogue Installation Systems.

Products for use in installation technology.

All facts about the fischer installation systems and their applications.

- Presentation of products and systems with detailed technical data and illustrations.
- Anchors suitable to fix installation system components.
- Application support.
- Basic knowledge of installation

Order now: info@fischer-international.com



7

Catalogue FireStop.

Products for use in passive fire protection.

The FireStop catalogue offers many facts and helps with fast and safe product selection, e.g.:

- Basics of passive fire protection
- Product and system presentations
- Application aids
- Detailed technical data and drawings

Order now: verkaufsinendienst@fischer.de

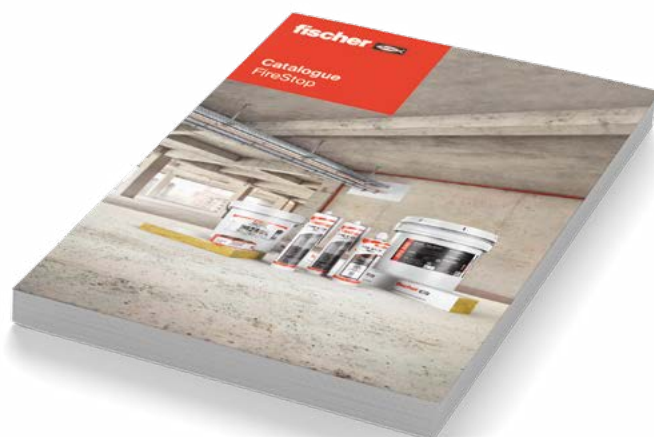

Catalogue Façade Systems.

All facts about the fischer façade range and its applications.

The Façade Systems catalogue offers many facts and helps with quick and safe product selection, e.g.:

- Presentation of Zykon panel anchor, machine technology, drill bits, subframes, general fixing products and accessories with detailed technical data and illustrations.
- Application support.
- Basic knowledge about undercut anchors and subframe systems.
- Available design software



7

Order now: info@fischer.com

Catalogue Cast-in Channels.

Products and applications of the fischer Cast-in Channel systems.

The Cast-in Channel catalogue shows innovative and secure solutions, offers comprehensive information and helps with a quick selection of system components.

- Presentation of the bolt and rail types and their possible combinations, with detailed technical data and illustrations
- Application support and references
- Basic knowledge on applications, processing and services
- Available design software



Order now: info@fischer.com

Catalogue Screws.

All facts about the fischer screw range and their applications.

Our catalogue for screws offers you a quick and reliable product selection. You will find many facts in it, such as:

- Presentation of products with detailed technical data and illustrations.
- Load tables for construction screws.
- Application support.
- Basic knowledge about connections with screws
- Available design software.

Order now: info@fischer-international.com



Germany

fischer Deutschland Vertriebs GmbH
Klaus-Fischer-Straße 1
72178 Waldachtal
P +49 7443 12 - 6000
F +49 7443 12 - 4500
info@fischer.de
www.fischer.de

Argentina

fischer Argentina S.A.
Armenia 3044
1605 Munro Ra-PCIA Buenos Aires
T +54 1147 62 27 78
F +54 1147 56 13 11
asistenciatecnica@fischer.com.ar
www.fischer.com.ar

Austria

fischer Austria GmbH
Wiener Straße 95
2514 Traiskirchen
T +43 2252 53730 0
F +43 2252 53730 70
office@fischer.at
www.fischer.at

Belgium

fischer Cobemabel snc
Schaliënhoeverdreef 20 D
2800 Mechelen
T +32 152 8 47 00
F +32 152 8 47 10
info@fischer.be
www.fischer.be

Brazil

fischer Brasil Indústria Comércio Ltda.
Estrada do Dende, 300 Ilha do Governador
21920-001 Rio de Janeiro-RJ
T +55 21 2467 11 30
F +55 21 2467 01 44
fischer@fischerbrasil.com.br
www.fischerbrasil.com.br

China

fischer (Taicang) fixings Co. Ltd.
No. 17, Lane 166, Guchuan Road, 14th
Floor, Building 2, Zhongjun Tianyue Center
200333 Shanghai
T +86 21 51 00 16 68
F +86 21 65 97 96 22
fiscn@fischer.com.cn
www.fischer.com.cn

Denmark

fischer a/s
Sandvadsvej 17 A
4600 Køge
T +45 46 32 02 20
F +45 46 32 50 52
fidk@fischerdanmark.dk
www.fischerdanmark.dk

Finland

fischer Finland Oy
Suomalaistentie 7 B
02270 Espoo
T +358 20 741 46 60
F +358 20 741 46 69
orders@fischerfinland.fi
www.fischerfinland.fi

France

fischer S. A. S.
12, rue Livio, P. O. Box 10182
67022 Strasbourg-Cedex 1
T +33 388 39 18 67
F +33 388 39 80 44
info@fischer.fr
www.fischer.fr

Greece

fischer Hellas
Kalavriton 2 & Kaiafa
14564 Kifissia, Athens
T +30 21 02 83 81 67
F +30 21 02 83 81 69
info@fischer.gr
www.fischer.gr

Hungary

fischer Hungária Bt.
Szerémi út 7/b
1117 Budapest
T +36 1 347 97 55
F +36 1 347 97 66
info@fischerhungary.hu
www.fischerhungary.hu

India

fischer Building Materials India PVT Ltd.
Unit 101, First Level, No. 3 (Old 4),
Prestige Sigma, Vittal Mallya Road,
Ward No. 76, Richmond Town
560001 Bangalore, Karnataka
T +91 0804 1511 991/92/93
F +91 0804 1511 989
info@fischer.in
www.fischer.in

Italy

fischer italia S.r.L
Corso Stati Uniti, 25, Casella Postale 391
35127 Padova Z.I. Sud
T +39 049 8 06 31 11
F +39 049 8 06 34 01
sercli@fischeritalia.it
www.fischeritalia.it

Japan

fischer Japan K.K.
Seishin Kudan Building 3rd Floor 3-4-15
Kudan Minami Chiyoda-ku, 102-0074 Tokyo
T +81 33 26 34 49 1
F +81 36 27 29 93 5
info@fischerjapan.co.jp
www.fischerjapan.co.jp

Mexico

fischer Sistemas de Fijación, S.A. de C.V.
Blvd. Manuel Avila Camacho 3130-400B
54020 Col. Valle Dorado, Tlalnepantla
T +52 55 55 72 08 83
F +52 55 55 72 15 90
info@fischermex.com.mx
www.fischermex.com.mx

The Netherlands

fischer Benelux B.V.
Gooimeer 14
1411 DE Naarden
T +31 35 6 95 66 66
F +31 35 6 95 66 99
info@fischer.nl
www.fischer.nl

Norway

fischer Norge AS
Oluf Onsumsvei 9
0680 Oslo
T +47 23 24 27 10
F +47 23 24 27 13
ordre@fischernorge.no
www.fischernorge.no

The Philippines

fischer PH Asia, Inc.
No 100 Congressional Avenue, Project 8
1106 Quezon City, Metro Manila
T +63 28 36 25 102
F +63 28 80 32 56
joselito.ladlad@fischerph.com
www.fischer.ph

Poland

fischer Polska Sp.z o.o.
 ul. Albatrosow 2
 30-716 Kraków
 T +48 12 2 90 08 80
 F +48 12 2 90 08 88
 info@fischerpolska.pl
 www.fischerpolska.pl

Portugal

fischerwerke Portugal, Lda.
 Rua das Musas, Passeio dos Cruzados
 Lote 2.01 (Bloco3), Loja 8 (01.D) / Parque
 das Nações, 1990-171 Lisboa
 T +351 218 954 180
 F +351 218 967 066
 fischerportugal.info@fischer.pt
 www.fischer.pt

Qatar

fischer fasteners QD Trading WLL
 Building No. 233, Office No. 8A, 1st Floor,
 Street No. – 230, Zone No. 41 C Ring Road,
 35190 Doha
 enquiry@fischer.qa
 www.fischer.qa

Romania

fischer fixings Romania S.R.L.
 Strada Oradiei, Nr. 1-3-5-7
 400220 Cluj Napoca, Judetul Cluj
 T +40 264 455 166
 F +40 264 403 060
 zoltan.kovacs@fischer.com.ro
 www.fischer.com.ro

Russia

OOO fischer Befestigungssysteme Rus
 Leningradskoe shosse, 47, Bldg. 2, 2nd
 floor, apt. VI, 125195 Moscow
 T +7 495 223 61 62
 F +7 495 223 03 34
 info@fischerfixing.ru
 www.fischerfixing.ru

Singapore

fischer systems Asia Pte. Ltd.
 4 Kaki Bukit Avenue 1, #01-06
 417939 Singapore
 T +65 6741 0480
 F +65 6741 0481
 sales@fischer.sg
 www.fischer.sg

Slovakia

fischer SK. s.r.o.
 Nová Rožňavská 134 A
 831 04 Bratislava
 T +421 2 4920 60 46
 F +421 2 4920 60 44
 info@fischerwerke.sk
 www.fischer-sk.sk

Spain

fischer ibérica S.A.U.
 Klaus Fischer 1
 43300 Mont-Roig del Camp Tarragona
 T +34 977 83 87 11
 F +34 977 83 87 70
 servicio.cliente@fischer.es
 www.fischer.es

South Korea

fischer Korea Co., Ltd (fikir)
 2nd Floor, Samryung Bd. 55
 Maeheon-ro 6-gil, Seocho-gu,u, Seoul,
 Korea 08390
 T +82 1544 89 55
 F +82 1544 89 03
 info@fischerkorea.com
 www.fischerkorea.com

Sweden

fischer Sverige AB
 Nygatan 93
 602 34 Norrköping
 T +46 11 31 44 50
 info@fischersverige.se
 www.fischersverige.se

Türkiye

fischer Metal Sanayi Ve Ticaret Ltd Şti
 Cevizli Mahallesi Mustafa Kemal Paşa Cad.
 Seyit Gazi Sok. No 66, Hukukçular Towers A
 Blok, 34865 Kartal İstanbul
 T +90 216 326 00 66
 F +90 216 326 00 18
 info@fischer.com.tr
 www.fischer.com.tr

United Kingdom (UK)

fischer fixings UK Ltd.
 Whitely Road
 Oxon OX10 9AT Wallingford
 T +44 1491 82 79 00
 F +44 1491 82 79 53
 info@fischer.co.uk
 www.fischer.co.uk

Unites States of America

fischer fixings LLC (fius)
 205 US HWY 46, Suite 4 07512 Totowa,
 New Jersey
 T +1 973 256 30 45
 F +1 845 625 26 66
 sales@fischerus.net
 www.fischerfixings.com

United Arab Emirates

fischer FZE
 R/A 07, BA - 04, Jebel Ali Free Zone
 Dubai P.O. Box 261738
 T +97 14 8 83 74 77
 F +97 14 8 83 74 76
 enquiry@fischer.ae
 www.fischer.ae

Vietnam

**fischer production Company Limited –
 Tay Ninh Branch**
 Lot 36-23-B, 36-24, D14A Road, Phuoc
 Dong Industrial Park, Phuoc Dong Commu-
 ne, Go Dau District, Tay Ninh Province
 info@fischer.vn

The information in this catalogue is intended for general guidance only and is given without engagement. Additional information and advice on specific applications is available from our Technical Support Team. For this however, we require a precise description of your particular application.

All the data in this catalogue concerning work with our fixing elements must be adapted to suit local conditions and the type of materials in use.

If no detailed performance specifications are given for certain articles and types, please contact our Technical Service Department for advice.

fischerwerke GmbH & Co. KG
72178 Waldachtal
Germany

We cannot be responsible for any errors, and we reserve the right to make technical and range modifications without notice.

No liability is accepted for printing errors and omissions.

Dealer:

www.fischer-international.com



fischer stands for

Fixing Systems
Automotive
fischertechnik
Consulting
Electronic Solutions

fischerwerke GmbH & Co. KG
Klaus-Fischer-Straße 1 · 72178 Waldachtal
Germany
P +49 7443 12 - 0
www.fischer-international.com · info@fischer.de
